



K-RIG Series

User Guide

• KT2.0 • KT2.15 • KPAK2600



The Future of Sound. Made Perfectly Clear.

At KV2 Audio our vision is to constantly develop technologies that eliminate distortion and loss of information providing a true dynamic representation of the source.

Our aim is to create audio products that absorb you, place you within the performance and deliver a listening experience beyond expectations.

Important Safety Instructions

Before using your K-RIG, be sure to carefully read the applicable items of these operating instructions and the safety suggestions.

1. Read all product instructions.
2. Keep printed instructions, do not throw away.
3. Respect and reread all warnings.
4. Follow all instructions.
5. Do not use this unit near water, in unprotected outdoor areas or in rain or wet conditions.
6. Clean only with dry cloth.
7. Do not block any ventilation openings.
8. Install in accordance with KV2 Audio's recommended installation instructions.
9. Do not install near any heat sources such as heat radiators, heat registers, stoves or other apparatus that produce heat.
10. Do not defeat the safety purpose of the grounding type plug. A grounding type plug has two blades and a third grounding connector. The third connector is provided for your safety. If the provided plug does not fit into your outlet, consult an electrician for replacement of the obsolete outlet.
11. Protect the power cord from being walked on or pinched, particularly at plugs, convenience receptacles. The AC mains plug or appliance coupler shall remain readily accessible for operation.
12. Only use accessories specified by KV2 Audio.
13. Install the product only with rigging specified by KV2 Audio, or sold with the loudspeaker.
14. Unplug this loudspeaker during lightning storms or when unused for long periods of time.
15. Refer all servicing to qualified service personnel. Servicing is required when the loudspeaker has been damaged in any way, such as when the power-supply cord or plug has been damaged; liquid has been spilled or objects have fallen into the loudspeaker; rain or moisture has entered the loudspeaker; the loudspeaker has been dropped; or when for undetermined reasons the loudspeaker does not operate normally.
16. Do not remove front or back panels. Removal of the panel will expose hazardous voltages. There are no user serviceable parts inside and removal may void the warranty.
17. An experienced user shall always supervise this professional audio equipment.

**CAUTION: TO REDUCE THE RISK OF ELECTRIC SHOCK, DO NOT REMOVE THE PANELS.
NO USER-SERVICEABLE PARTS INSIDE. REFER SERVICING TO QUALIFIED PERSONNEL.**

WARNING: To prevent fire or electric shock, do not expose this equipment to rain or moisture.

SAFETY SUMMARY

To reduce the risk of electric shock, disconnect the loudspeaker from the AC mains before installing audio cable. Reconnect the power cord only after making all signal connections. Connect the loudspeaker to a twopole, three-wire grounding mains receptacle. The receptacle must be connected to a fuse or circuit breaker. Connection to any other type of receptacle poses a shock hazard and may violate local electrical codes. Do not allow water or any foreign object to get inside the loudspeaker. Do not put objects containing liquid on or near the unit. To reduce the risk of overheating the loudspeaker, avoid exposing it to direct sunlight. Do not install the unit near heat-emitting appliances, such as a room heater or stove. This loudspeaker contains potentially hazardous voltages. Do not attempt to disassemble the unit. The unit contains no user serviceable parts, repairs should be performed only by factory trained service personnel.

Content

Introduction K-RIG Series	4
Introduction K-RIG Series	4
KPAK2600	5
Introduction	5
Overview	6
Getting started	7
Features · Upper panel	8
Features · Bottom panel	9
Specifications	10
Block diagram	11
Using the system	12
KT2.0	13
Overview	13
Specifications	14
Drawing	15
KT2.15	16
Overview	16
Specifications	17
Drawing	18
Accessories	19
Basic Configurations	20
Warranty · Service	21



K-RIG

Introduction K-RIG Series

Thank you for purchasing this KV2 Audio - K-RIG system, consisting of the KPAK2600 controller/amplifier unit, KT2.0 Mid/Hi speakers and one or two KT2.15 subwoofers per side of the stereo system. The K-RIG system has been developed as a high output, easy to use system, where a competitive price is important. The K-RIG system has purposely been designed to be used as a ground stack, accordingly the KT2.0 cannot be used separately without the KT2.15 and K-RIG must be assembled as described in the enclosed user guide part "Using the system".

Similar to our popular ES range, the K-RIG cabinets are fully active - driven by a proprietary amplifier, which delivers equalized, and time aligned accurate signal to each of the components. One KT2.0 mid hi enclosure and up to two KT2.15 subwoofers can be driven by a single KPAK2600 Amplifier, which houses all signal processing and amplification, as well as providing signal outputs for external additional subwoofer cabinets if required.

Please take some time to read this manual, to familiarize yourself with the advanced features of this system.

The amplifier compliment inside the KPAK2600 Amplifier is configured as:

- High Frequency - 200-watt, Class AB, Push pull, Low intermodulation design
- Mid Frequency - 500-watt, Class AB, High efficiency, Switch mode, Low intermodulation design
- Low Frequency - 1600-watt, High-efficiency, Current-enhancing switch mode with Linear Active Filter

In most cases it would be advisable to use a KV2 Audio Line driver, (LD4) in addition between the mixer outputs and KPAK2600 Amplifier, to ensure that the line to the amplifier is driven correctly and the signal integrity maintained. Although this system is simple to operate, improper use can be dangerous. This is a very high-powered device that can put out high voltages and sizeable currents. Always use safe operating techniques with the K-RIG system.

FOR YOUR SAFETY, READ THE IMPORTANT PRECAUTIONS SECTION AS WELL AS THE INPUT, OUTPUT AND POWER CONNECTION SECTIONS OF THIS MANUAL.

KPAK™ 2600 Electronic Control & Amplification System

KPAK2600 - part number
KVV 987 324 (250V)
KVV 987 317 (230V)
KVV 987 323 (115V)



Application

Specifically designed as the amplification and control elements for the K-RIG loudspeaker systems

- Portable PA
- Dance clubs
- Reproduced music

Introduction

KPAK2600 is a three-way, active control and amplification unit specifically designed for the K-RIG Groundstack loudspeaker system. It houses all signal processing and three individual amplifiers in a road-rugged enclosure with built in cable storage compartment with suspension system and passive heat sink along with two demand-sensitive fans for added reliability.

Features

- 3-way, 2300W Control and Amplification system for use specifically with KT2.0 and KT2.15 speaker cabinets
- High Frequency, 200W, Class AB, push-pull, low intermodulation amplifier with transformer balanced outputs
- Mid frequency, 500W, Class AB, high efficiency, switch mode, low intermodulation design amplifier
- Subwoofer, 1600W, high efficiency, current enhancing, switching amplifier
- Complete, on board speaker management system including equalization, time alignment, crossover filters, amplifier overdrive protection, harmonics and output level controls
- AC soft start circuitry with ON/OFF AC breaker switch provides thorough power protection
- Passive heat dissipation design with demand-sensitive forced cooling back-up system
- Removable front cover provides storage of all AC and speaker cables
- Bass Character- Attack or extension switch alters the low frequency character
- Includes all speaker cables for a single stack K-RIG system

Unpacking

Unpack the KPAK2600 and check to see if there is any damage to it. If you find any damage notify your supplier immediately. Only the consignee may institute a claim with the carrier for any damage incurred during shipping. Be sure to save the carton and all packaging materials for the carrier's inspection. Should you ever need to ship the unit, only use the original factory packing. If the shipping carton is unavailable, contact your supplier to obtain a replacement.

Mounting

For additional reliability, the amplifier unit is mounted on a suspension system that isolates it from the shocks and impacts typically encountered on the road. For installations, use the EPAK2500 Wall mounting kit KVV 987 024.

The K-RIG Ground stack carton should contain:

- KPAK2600 Amplifier unit
- KT2.0 – Ground stack Active-Driven Mid-Hi module
- KT2.15 – Ground stack Active-Driven Bass module
- PowerCon detachable power cable
- Speakon cable 4.15 - 1,5m 4pin Speakon cable
- Speakon cable 4.40 - 4m 4pin Speakon cable for KT2.15
- Speakon cable 8.60 - 6m 8pin Speakon cable for KT2.0

AC Power requirements

The KPAK2600 uses a standard PowerCon connector. The device must be connected to a suitable mains socket outlet with protective earthing connection.

Caution

The PowerCon is a connector without breaking capacity, i.e. the PowerCon should not be connected or disconnected under load or while it is alive. Always isolate your AC supply before disconnecting the PowerCon connector. If the On LED does not illuminate or the system does not respond to audio input remove AC power immediately. Verify that the voltage is within the proper range. If the problem persists, please contact KV2 Audio or an authorized service center.

Voltage requirements

Your KPAK2600 will be supplied pre set to the voltage used in your area. The table below provides typical current draw figures for the KPAK2600.

Cooling

The KPAK2600 has a comprehensive passive cooling system with demand-sensitive forced cooling backup, via speed controlled fans.

This means that the cooling system never drives air across PCB boards, connectors or components, ensuring prolonged electronic component lifespan and minimizing maintenance cycles.

It is important to have an adequate air supply around the amplifier allow the cooling air to flow. Do not expose the amplifier heat sink to direct sunlight.

If the heat sink gets too hot, its sensing circuit will open the output relay, disconnecting the load.

AC Input	Current draw with amplifier running at Average Power	Current draw with amplifier running at Peak Power
250V	8.25A	12.5A
230V	9A	14A
115V	18A	28A

Upper panel

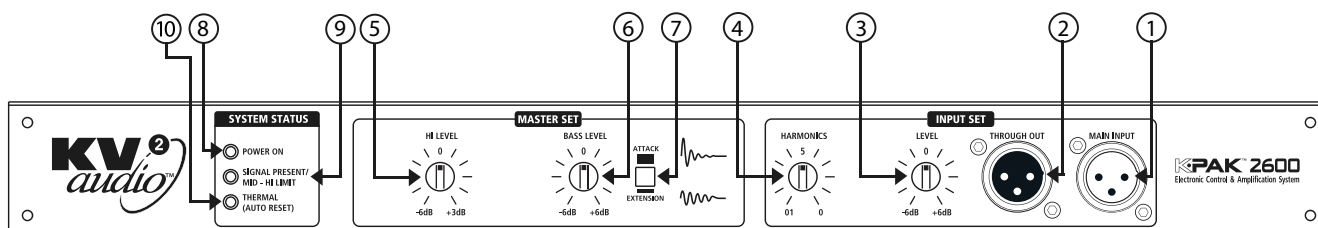

Input set

1) Main Input

This is the main system balanced signal input connector.

2) Through signal out

Through Signal Output' connector associated in parallel with Main input for sending unprocessed signal to other devices, such as more KPAK2600's to power more KPAK2600's in a system.

3) Level

Adjusts the output level from -6dB to +6dB. This is the master level control for the system and will act on both the KT2.0 and the subwoofer output for the KT2.15.

4) Harmonics

This level knob serves as a harmonic expander, and adds harmonics to the original sound. This control serves to optimize performance of poor quality recordings, audio sources and devices. The Harmonics knob creates more high frequencies from the mid frequencies and 'lights up' the sound, giving an impression of space and improved intelligibility.

Master set

5) Hi Level

This is the level control for the Hi frequency driver output from -6dB to +3dB; it is 'post' the Master Level control.

6) Bass Level

This is the level control for the Low frequency driver output from -6dB to +3dB; it is 'post' the Master Level control.

System status

7) Attack / Extension

This switch turns on the Low frequency enhancement circuitry (EXTENSION position) which boosts frequencies around 60Hz to enhance the lowest frequency band.

8) Power ON

This is a dual color LED, when green it indicates that the AC power is on. When red it indicates that the audio bass amplifier limiter has been activated.

9) Signal preset / Mid - Hi limit

This is a dual color LED, green indicates when audio signal is present at the KPAK2600's input. When red it indicates that the audio mid-hi amplifier limiter has been activated.

10) Thermal (auto reset)

When red it indicates that the thermal limit of the KPAK2600 has been exceeded and the unit has shut down because of this.

Bottom panel

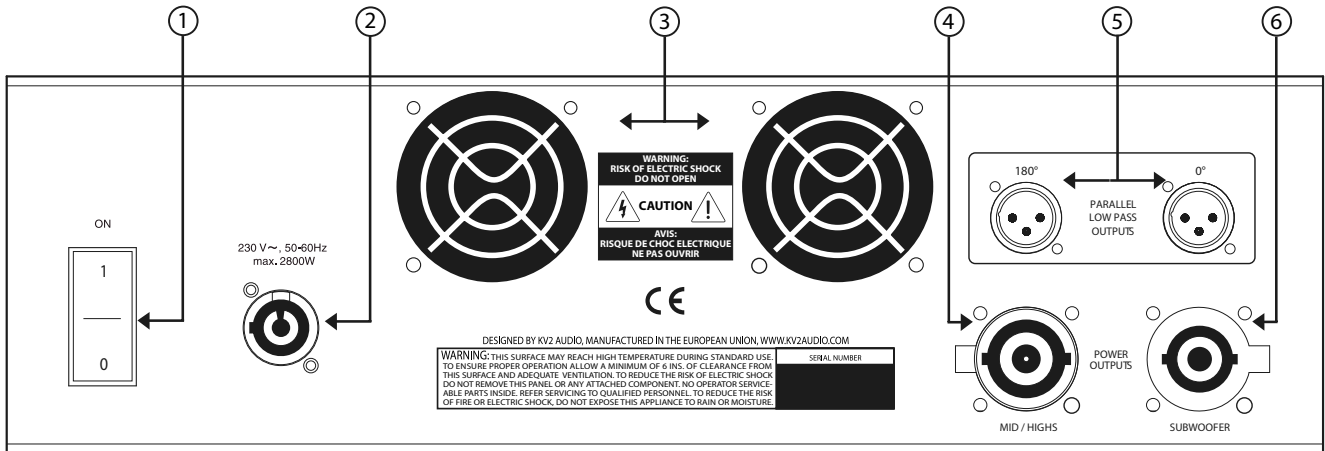

1) AC Mains switch

The KPAK2600 has a combination AC Mains switch/circuit breaker on the bottom panel. If the switch shuts off during normal use, push it back to the ON position once. If it will not stay on you should take the unit to qualified service personnel to have it serviced.

2) PowerCon Power Connector

Accepts a standard PowerCon terminated AC cable.

3) Fans

The cooling fans operate continuously while the KPAK2600 is on. An internal temperature sensor increases the speed of the fans during high temperature conditions.

4) Mid/Hi power output connector

Accepts a standard 8-pole Speakon terminated loudspeaker cable for connecting up to a single KT2.0 cabinet. We recommend using original KV2 Audio cables (1.5m, 4pole Speakon cable - KVV 987 328 or 6m, 4pole Speakon cable – KVV 987 327)

5) Parallel low pass outputs

Allows you to connect additional subwoofers. Output 0° is in phase with the KT2.15 subwoofer output. Output 180° is phase reversed to the KT2.15 subwoofer output.

6) Subwoofer power output connector

Accepts a standard 4-pole terminated loudspeaker cable for connecting up to single KT2.15 or two KT2.15 subwoofers in parallel. We recommend using original KV2 Audio cables (4 Pole Speaker Cable – KVV 987 326 or KVV 987 327).

Specifications

High Frequency Amplifier Specification

Type	Class AB, Push Pull, Low IM Design, Transformer Balanced Output
Rated Continuous Power	200W
Distortion	<0.05%
Operating Bandwidth	1.4kHz to 20kHz

Mid Frequency Amplifier Specification

Type	High efficiency, Current-Enhancing, Switched-Rail Amplifier
Rated Continuous Power	500W
Distortion	<0.05%
Operating Bandwidth	180Hz to 1.4kHz

Low Frequency Amplifier Specification

Type	High efficiency, Low Frequency, Current-enhancing Switch Mode
Rated Continuous Power	1800W
Distortion	<0.05%
Operating Bandwidth	20Hz to 200Hz

Signal Input

Input Sensitivity	1V RMS
Input Impedance	20k Ω (balanced)

Speaker Output

Speaker Output	Speakon 8pin (Mid/Hi), 4pin (Sub)
----------------	-----------------------------------

Power

Power Connector	Neutrik PowerCon [®]
Operating Voltage	100 to 120V@60Hz 205 to 240V@50Hz 225 to 260V@50Hz
Recommended Amperage	20A 115V 10A 230V 10A 250V

Physical Dimensions

Height	719 mm (28.30")
Width	478 mm (18.81")
Depth	305 mm (12.00")
Weight	38 kg (83.78lbs)

Block diagram

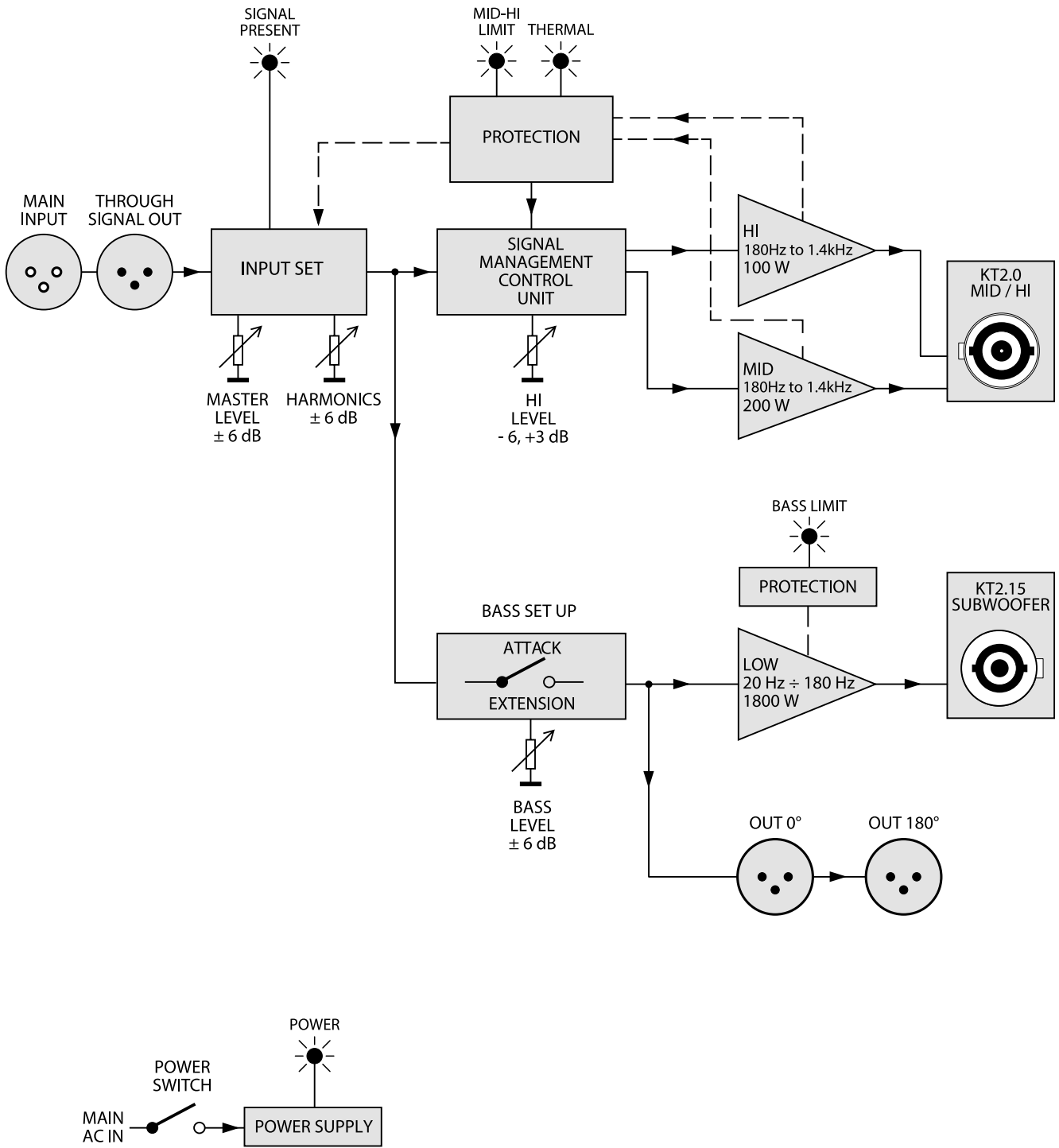

Using the system

The KPAK2600 is designed to actively power one KT2.0 Mid/Hi cabinet and associated one KT2.15 or two KT2.15 subwoofers in parallel.

The K-RIG System is designed to be used as a ground stack. The KT2.15 subwoofers serve as the base for the KT2.0 Mid/Hi cabinet and the KT2.0 and KT2.15 cabinets **MUST** be installed close together.

If the system were installed separately, it negatively affects the sound quality and dispersion because of the incorrect phase addition of the low mid drivers.

The KT2.0 Mid/Hi can be stacked on the one or two KT2.15 subwoofers.

KT2.0 Mid/Hi with two KT2.15 subwoofers

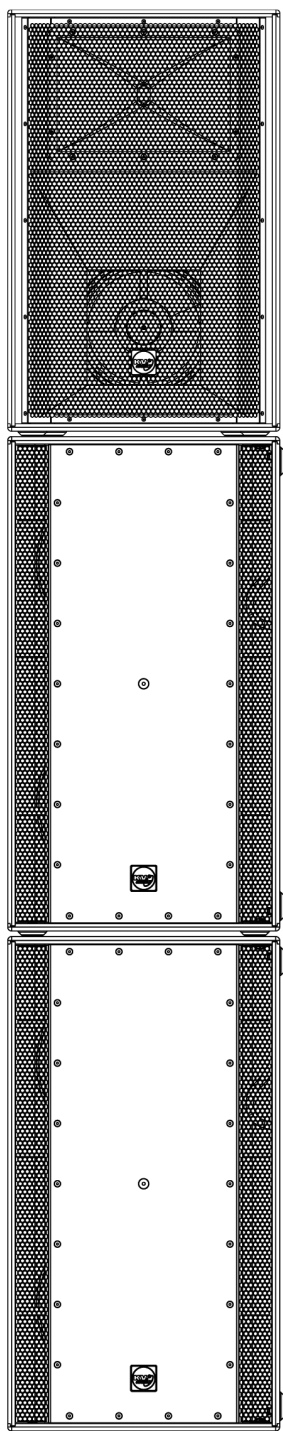

KT2.0 Mid/Hi with two KT2.15 subwoofers

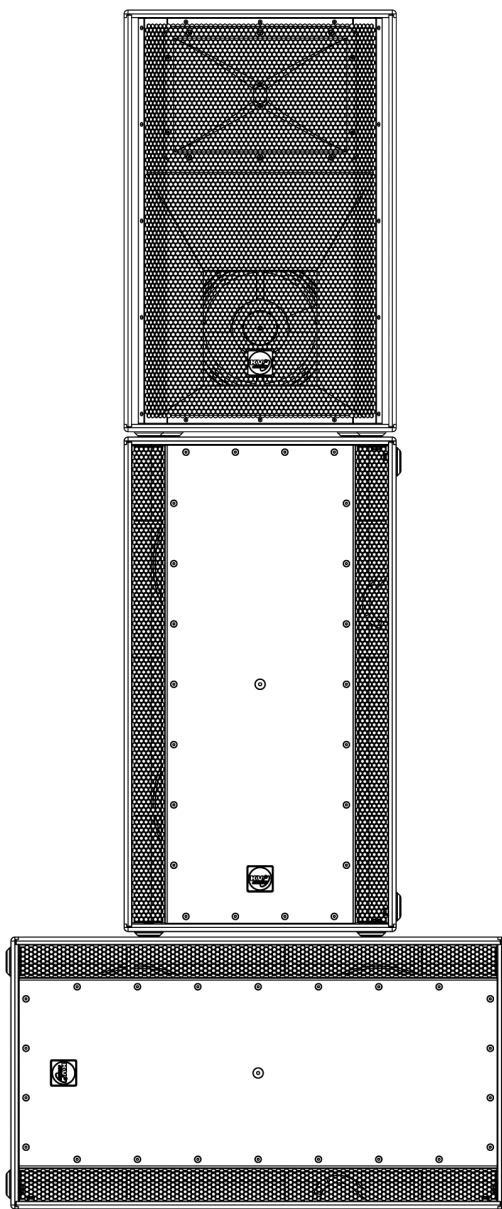

KT2.0 Mid/Hi with one KT2.15

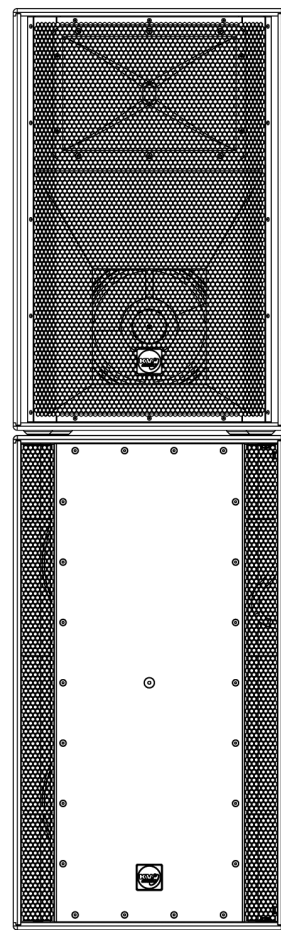

KT2.0

MID/HI MODULE

K-RIG Active-Driven Mid-Hi module

KT2.0 - part number KVV 987 314



Application

Specifically designed as a Mid/Hi speaker for the K-RIG loudspeaker systems

- Portable PA
- Dance clubs
- Reproduced music

Introduction

The KT2.0 is the Mid High Module for K-RIG. Its two-way horn loaded design provides optimal output and coverage that far exceeds that of a normal frontloaded 12 and horn box or a number of small line array elements. It consists of a horn loaded high power 12" mid bass speaker with integral phase plug and a 2.5" titanium diaphragm compression driver on an 80° H x 40° V constant directivity, wide dispersion horn. The KT2.0 is driven and controlled by two channels of the K-PAK controller amplification system and must be used with two KT2.15 bass speakers. It is constructed of baltic birch to reduce weight for ease of stacking and coated in a heavy-duty, wear resistant polymer coating.

Features

- Professional Baltic birch construction with wear resistant polymer coating
- 132dB sustained output, 135dB peak
- Controlled wide dispersion 80° x 40°
- 2.5" (64 mm) Titanium diaphragm compression driver with complex geometry phase plug and ferrite magnetic structure
- Horn loaded, 12" mid-bass driver, with a 2.5" (64 mm) voice coil and ferrite magnetic structure
- Two way active requirement - 700W from the KPAK Amplifier providing 500W for the 12" low mid and 200W for the high frequency driver
- Proprietary side handle design for simplified handling and carrying
- High impact low friction feet, for lock-in and easy cabinet movement

Specifications

System Acoustic Performance

Max SPL Long-term	132dB
Max SPL Peak	138dB
-3dB Response	(+ 2x KT2.15: 42Hz) 180Hz to 18kHz
Crossover Point	180Hz / 1.4kHz

High Frequency Section

Acoustic Design	Horn Loaded
High Horn Coverage Horizontal / Vertical	80° x 40°
Throat Exit Diameter / Diaphragm Size	1.4" / 2.5"
Diaphragm Material	Titanium
Magnet Type	Ferrite

Mid-Bass Section

Woofers Size / Voice Coil Diameter / Design	12" / 2.5" / Inside Outside
Diaphragm Material	Epoxy Reinforced Cellulose
Magnet Type	Ferrite

Speaker Input

Speaker Input	2x Neutrik Speakon® - NL8
---------------	---------------------------

Cabinet

Cabinet Material	Baltic birch
Handles	2
Pole Mount	1
Color	"Orange peeled" Matt Black

Physical Dimensions

Height	852 mm (33,54")
Width	550 mm (21.66")
Depth	375 mm (14.76")
Weight	40 kg (88.2lbs)

Drawing

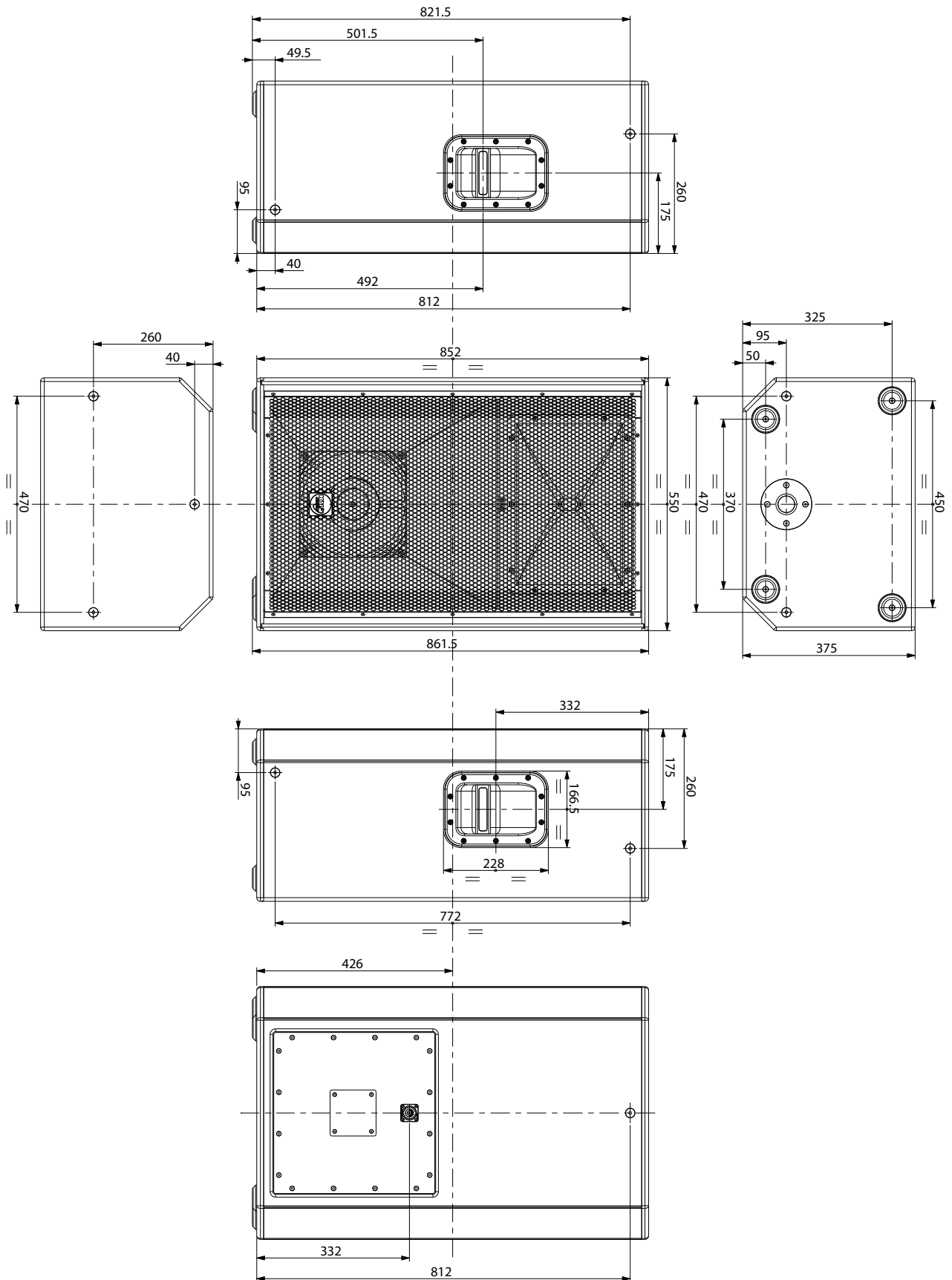

KT 2.15

BASS MODULE
K-RIG Active-Driven Bass module

KT2.15 - part number KVV 987 315

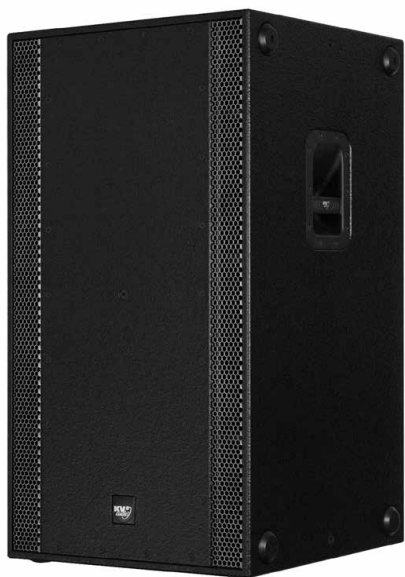

Application

Specifically designed as a subwoofer of K-RIG loudspeaker systems

- Portable PA
- Dance clubs
- Reproduced music

Introduction

The KT2.15 is a subwoofer designed as a part of K-RIG loudspeaker system. Incorporating quality components specially matched with electronics, the unit is designed for varied applications, with extreme output and quality performance when accompanied by the KT2.0 Mid/Hi module as a system.

Parts of the Ground stack Active Driven System The KT2.15 double 15" subwoofer is compact, designed as a part of the K-RIG system Active Driven by the KPAK2600 amplifier / controller.

Features

- Professional, Baltic birch construction with wear resistant polymer coating
- 130dB sustained output, 133dB peak
- Excellent reproduction of bass frequencies with high transient content at high output levels
- 2 x 15" high output, low frequency driver with 3" (75 mm) inside/outside, epoxy baked, high temperature, voice coil assembly and ferrite magnetic structures
- Two recessed side handles for simplified handling and carrying

Specifications

System Acoustic Performance

Max SPL Long-term	130dB (133dB 2 Units)
Max SPL Peak	136dB (139dB 2 Units)
-3dB Response	42Hz to 180Hz
Impedance	8Ω

Low Frequency Section

Acoustic Design	Twin Asymmetrical loading
Woofer Size / Voice Coil Diameter / Design	15" / 3" / Inside Outside

Speaker Input

Speaker Input	2x Neutrik Speakon® - NL4
---------------	---------------------------

Cabinet

Cabinet Material	Baltic birch
Handles	2
Pole Mount	1
Color	"Orange peeled" Matt Black

Physical Dimensions

Height	1000 mm (39.37")
Width	550 mm (21.65")
Depth	570 mm (22.44")
Weight	61 kg (134.5lbs)

Drawing

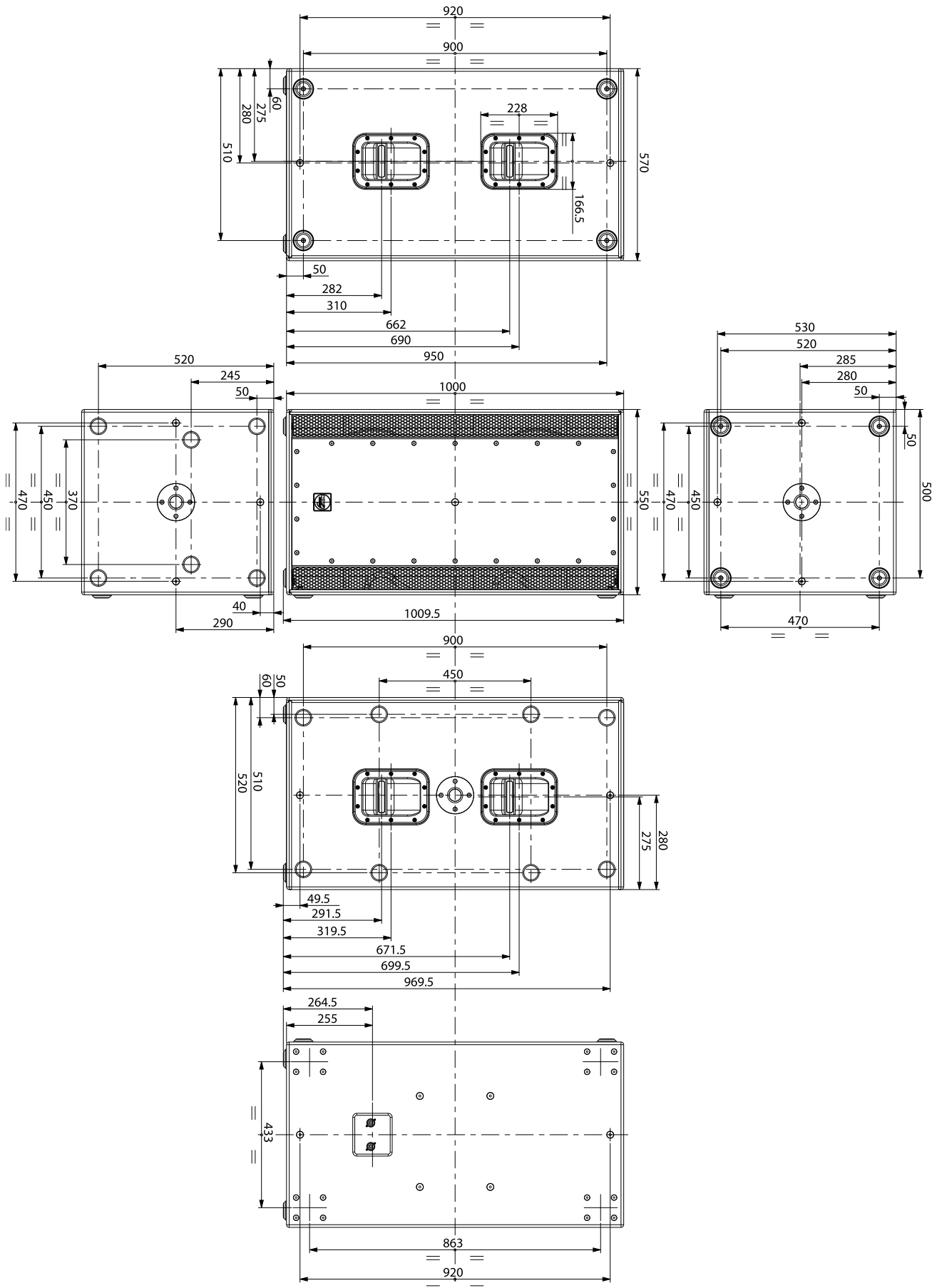

Cart Wheels

part name:

Cart Wheels (Cart 0009)

part number:

KVV 987 128

description:

- with bolts nut kit
- 4 pcs in pack, rotating, blue
- 16x M8x 35mm Screw Countersunk Hexagon Socket Head
- 16x Nut Hexagon with blue plastic insert M8

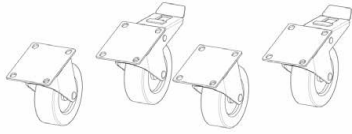

KT2.15 Wheels kit

part name:

CRT 009 KT2.15 Whl kit

part number:

KVV 987 355

description:

- 4x Wheel (2x with brake)
- 16x M8x16mm Screw Hexagon Head
- 16x M8 Washer Serrated

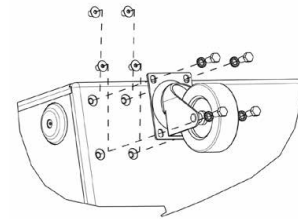

Short joining bracket for K-RIG

part name:

Short joining bracket for K-RIG

part number:

KVV 987 318

description:

- 2 pcs in pack
- 4 pcs Quick-lock-pins 6mm included
- 4 pcs M10 hex screws with a hole included



Wallmount bracket for KPAK2600/EPAK2500

part name:

Wallmount bracket for EPAK2500

part number:

KVV 987 332

description:

- wall mounting kit for installing an EPAK2500 or KPAK2600
- for 1pc EPAK2500 or KPAK2600

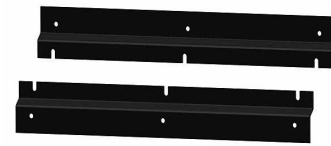

K-RIG Security pole

part name:

K-RIG SECURITY POLE

part number:

KVV 987 325

description:

- used to fix KRIG speakers among themselves
- 4 pcs in pack



Bass speaker cable Speakon 4.15

part name:

CABLE SPEAKON 4.15

part number:

KVV 987 326

description:

- 4 wire speaker cable
- Speakon NL4 connectors
- 1,5m (5ft)
- for K-RIG Bass Module hook-up



Bass speaker cable Speakon 4.40

part name:

CABLE SPEAKON 4.40

part number:

KVV 987 327

description:

- 4 wire speaker cable
- Speakon NL4 connectors
- 4m (13ft)
- for K-RIG Bass Module hook-up



Mid/Hi speaker cable Speakon 8.60

part name:

CABLE SPEAKON 8.60

part number:

KVV 987 328

description:

- 6 wire speaker cable
- Speakon NL8 connectors
- 6m (20ft)
- for K-RIG Mid/Hi Module hook-up



Basic Configurations

KT2.0 with two KT2.15

KT2.0 with one KT2.15

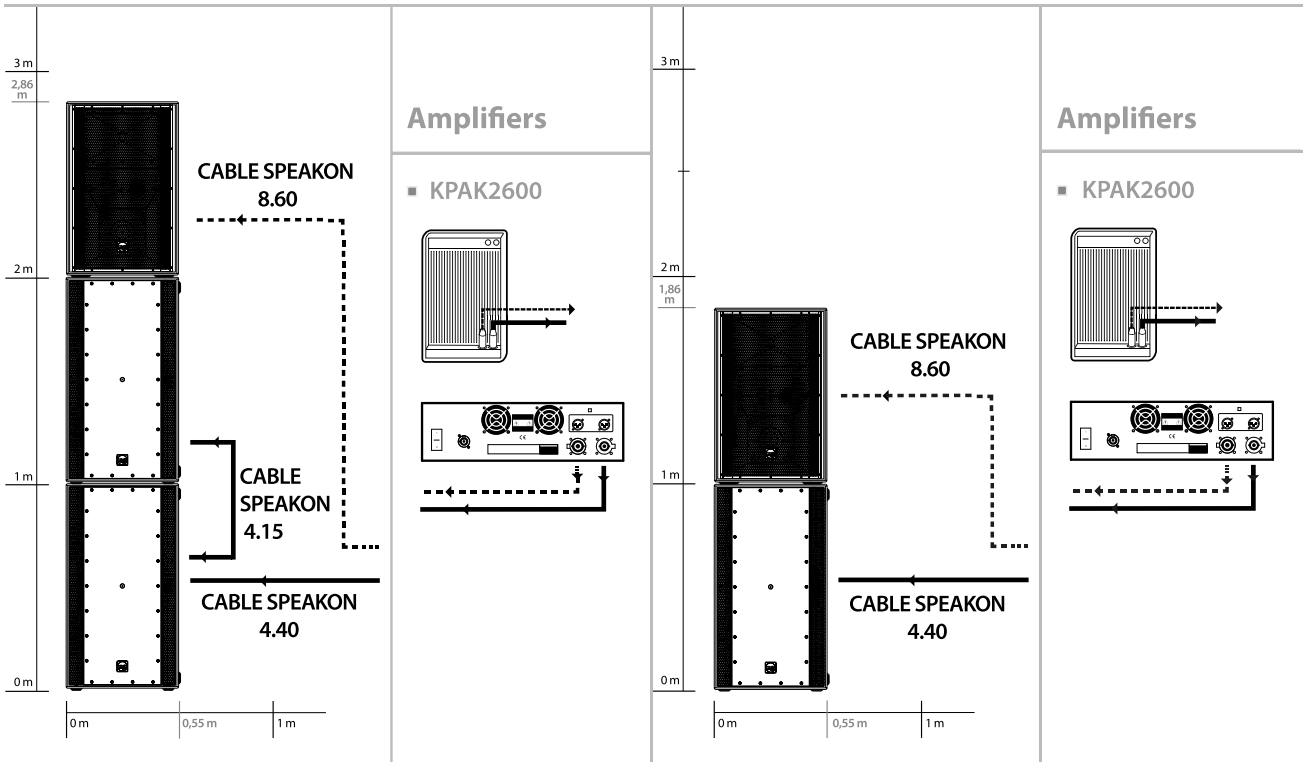

Two KT2.0 with two KT2.15 with external subwoofer 1x KT2.15 per side

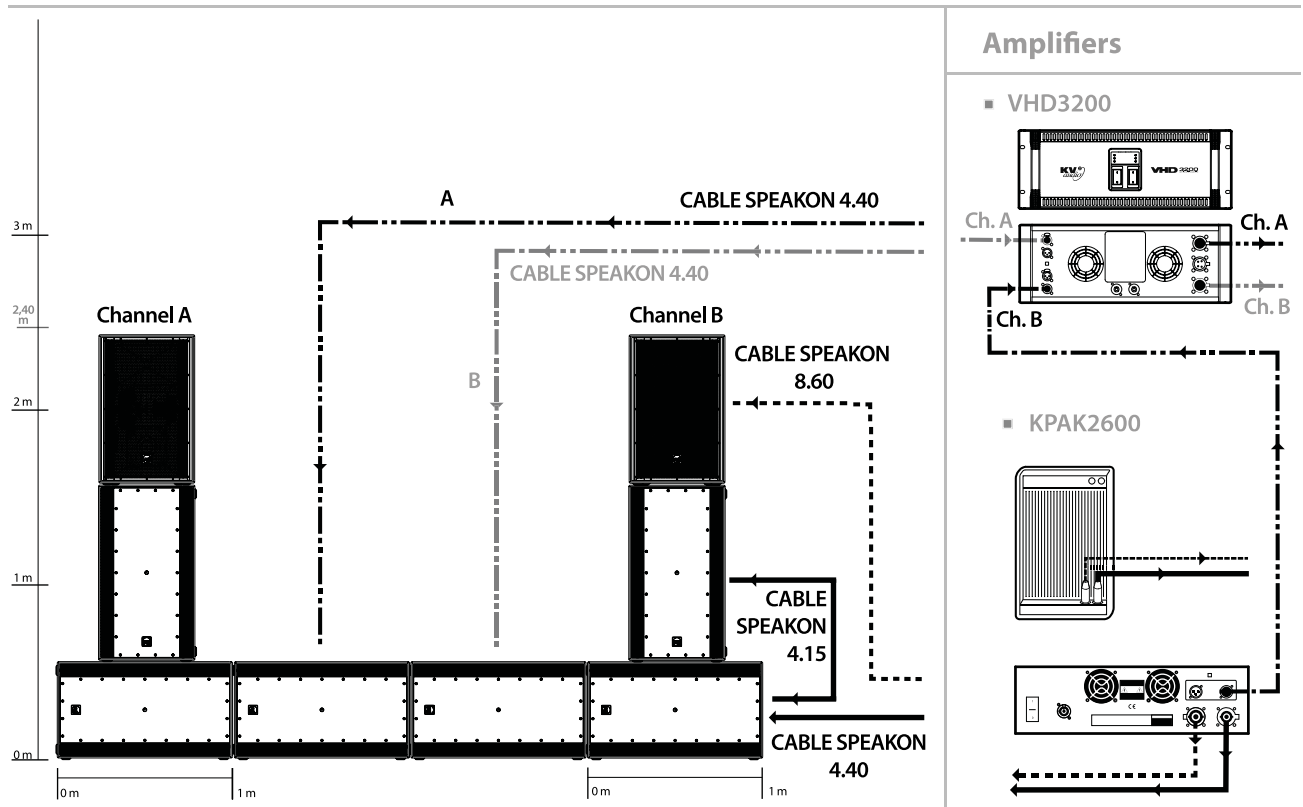

Number of bass boxes and SUB LEVEL setup - depend on music style.
One side of stereo single system.

Warranty

Your K-RIG Series is covered against defects in material and workmanship.

Refer to your supplier for more details.

Service

In the unlikely event that your K-RIG Series develops a problem, it must be returned to an authorized distributor, service centre or shipped directly to our factory. Because of the complexity of the design and the risk of electrical shock, all repairs must be attempted only by qualified technical personnel.

If the unit needs to be shipped back to the factory, it must be sent in its original carton. If improperly packed, the unit may be damaged.

To obtain service, contact your nearest KV2 Audio Service Centre, Distributor or Dealer.



The Future of Sound.
Made Perfectly Clear.

KV2 Audio International

Nádražní 936, 399 01 Milevsko
Czech Republic

Tel.: +420 383 809 320

Email: info@kv2audio.com

www.kv2audio.com

KVV120102-00-09-0