



SL Series User Guide

• SL412 • SL6.10 • SL3000



The Future of Sound. Made Perfectly Clear.

At KV2 Audio our vision is to constantly develop technologies that eliminate distortion and loss of information providing a true dynamic representation of the source.

Our aim is to create audio products that absorb you, place you within the performance and deliver a listening experience beyond expectations.

Important Safety Instructions

Before using your SL Series, be sure to carefully read the applicable items of these operating instructions and the safety suggestions.

1. Read all product instructions.
2. Keep printed instructions, do not throw away.
3. Respect and review all warnings.
4. Follow all instructions.
5. Do not use this unit near water, in unprotected out door areas or in rain or wet conditions.
6. Clean only with dry cloth.
7. Do not block any ventilation openings.
8. Install in accordance with KV2 Audio's recommended installation instructions.
9. Do not install near any heat sources such as heat radiators, heat registers, stoves or other apparatus that produce heat.
10. Do not defeat the safety purpose of the grounding type plug. A grounding type plug has two blades and a third grounding connector. The third connector is provided for your safety. If the provided plug does not fit into your outlet, consult an electrician for replacement of the obsolete outlet.
11. Protect the power cord from being walked on or pinched, particularly at plugs, convenience receptacles. The AC mains plug or appliance coupler shall remain readily accessible for operation.
12. Only use accessories specified by KV2 Audio.
13. Install the product only with rigging specified by KV2 Audio, or sold with the loudspeaker.
14. Unplug this loudspeaker during lightning storms or when unused for long periods of time.
15. Refer all servicing to qualified service personnel. Servicing is required when the loudspeaker has been damaged in any way, such as when the power-supply cord or plug has been damaged; liquid has been spilled or objects have fallen into the loudspeaker; rain or moisture has entered the loudspeaker; the loudspeaker has been dropped; or when for undetermined reasons the loudspeaker does not operate normally.
16. Do not remove front or back panels. Removal of the panel will expose hazardous voltages. There are no user serviceable parts inside and removable may void the warranty.
17. An experienced user shall always supervise this professional audio equipment.

**CAUTION: TO REDUCE THE RISK OF ELECTRIC SHOCK, DO NOT REMOVE THE PANELS.
NO USER-SERVICEABLE PARTS INSIDE. REFER SERVICING TO QUALIFIED PERSONNEL.**

WARNING: To prevent fire or electric shock, do not expose this equipment to rain or moisture.

SAFETY SUMMARY

To reduce the risk of electric shock, disconnect the loudspeaker from the AC mains before installing audio cable. Reconnect the power cord only after making all signal connections. Connect the loudspeaker to a twopole, three-wire grounding mains receptacle. The receptacle must be connected to a fuse or circuit breaker. Connection to any other type of receptacle poses a shock hazard and may violate local electrical codes. Do not allow water or any foreign object to get inside the loudspeaker. Do not put objects containing liquid on or near the unit. To reduce the risk of overheating the loudspeaker, avoid exposing it to direct sunlight. Do not install the unit near heat-emitting appliances, such as a room heater or stove. This loudspeaker contains potentially hazardous voltages. Do not attempt to disassemble the unit. The unit contains no user serviceable parts, repairs should be performed only by factory trained service personnel.

Content

Introduction SL Series	4
SL412	5
Overview	5
Drawings	6
Specifications	7
Technology	8
Frequency characteristics	9
SL6.10	10
Overview	10
Drawings	11
Specifications	12
Technology	13
SL3000	14
Overview	14
Drawings	15
Getting started	16
Features - Front panel	17
Features - Rear panel	18
Using the system - Full Range	19
Using the system - Subwoofers	20
Specifications	21
Block Diagram	22
Accessories	23 - 25
Configurations	26 - 28
Warranty · Service	29



Introduction SL Series

The SL412 and SL6.10 speakers incorporate an eye catching, slim, stylish cabinet design. Designed to integrate either externally through simple wall mounting, suspension, ground stacking, or internally into walls and surfaces. These units can be designed and supplied with custom colors, grill templates and logos, offering a flexible and true designer integration product. Using KV2 Super Live Audio technology, the SL412 loudspeaker utilizes 4 x 12" low mid-range components and the proven and highly respected horn assembly from the VHD1.0 with a single 8" mid-range and 3" large format NPVD compression driver. This mid-high horn has an extremely coherent-wide horizontal dispersion of over 110 degrees whilst the purpose designed 4 x 12" configuration dramatically reduces the most common problem of immediate reflections within the 300 to 800Hz range usually associated with wide dispersion loudspeakers.

The end result is a full and wide sound propagation exactly where it is required. Whilst the SL412 can be utilized with any of KV2's wide range of subwoofer systems depending on the actual application, the accompanying SL6.10 utilizes the same slim line design to allow for an aesthetically pleasing and acoustically punchy system that can virtually disappear against a wall. The SL6.10 incorporates 6 x 10" speakers in a specially designed shallow cabinet to output maximum bass response.

This manual contains important information on operating the SL system correctly and safely. Please take some time and read this manual to familiarize yourself with the advanced features of this system.

The SL3000/SL3000D Amplifier is a three-way, active control and amplification systems, specifically designed for the KV2 Audio SL series loudspeaker systems. It houses all signal processing and amplification as well as providing control for external subwoofer cabinets configurations, and to operate additional subwoofer cabinets if needed. External subwoofers are powered by the external subwoofer amplifier (VHD3200/VHD3200D).

In most cases it would be advisable to use a KV2 Audio Line driver (LD4) in addition at the mixer end to ensure that the line to the amplifier is driven correctly and the signal integrity maintained. Although this system is simple to operate, improper use can be dangerous. This is a very high-powered device that can put out high voltages and sizeable currents. Always use safe operating techniques with the SL series system.

For information on SL3000D amplifier please see perspective User Guide - KVV120149.

SL412 MID/HI MODULE

SL412 - part number KVV 987 273



Application

Custom designed as an aesthetically – easily integratable high performance unit for multi-tasking installation projects of recorded and live music performance

- Fixed installation
- Nightclubs
- Multi-use venues
- Large bars

Introduction

The SL412 is a slim, discreetly profiled cabinet with wide dispersion at high frequencies. The four twelve inch speaker configuration provides controlled low-mid focus to reduce indoor reflection. Its slim design allows for simple wall mounting, suspension, ground stacking, or internal wall fixing. The SL412 can be designed and supplied with custom colours, grille templates and logos, offering a flexible and true designer integration product. A single horizontal yoke assembly with multiple fixed angle and fixing locations, provides a quick and cost effective solution for simple suspension options.

Features

- Slim, discreetly profiled wall mount cabinet
- Wide dispersion at high frequencies, controlled at low-mids to reduce indoor reflections
- 134dB sustained output, 137dB peak with very high dynamic range
- Simple wall mounting and suspension, ground stacking options and can be installed internally into walls and surfaces
- These units can be designed and supplied with custom colors, grill templates and logos, offering a flexible and truly designer integrated product
- A single horizontal yoke assembly with multiple fixed angles and fixing locations, provides a quick and cost effective solution for simple suspension options

Slim-line Sound System Benefits

Total flexibility

The requirement for truly 'environment integrated' enclosures is always a difficult prospect, with large, or often deep enclosures protruding into and breaking up sight lines. Requests are often received from both architects and interior designers for less obtrusive units, whilst providing the highest integrity in sound quality, output and coverage.

Superb sound

KV2 Audio Slim-line system uses Super Live Audio technology with greater dynamic range than any current similar solution.

Easy set-up

Plug-and-play connection to SL3000/SL3000D amp/processor module. Slim, discreetly profiled, wall mount design. Cabinet features two handles, eight suspension points and "integral feet" for easy positioning on stage.

Drawings

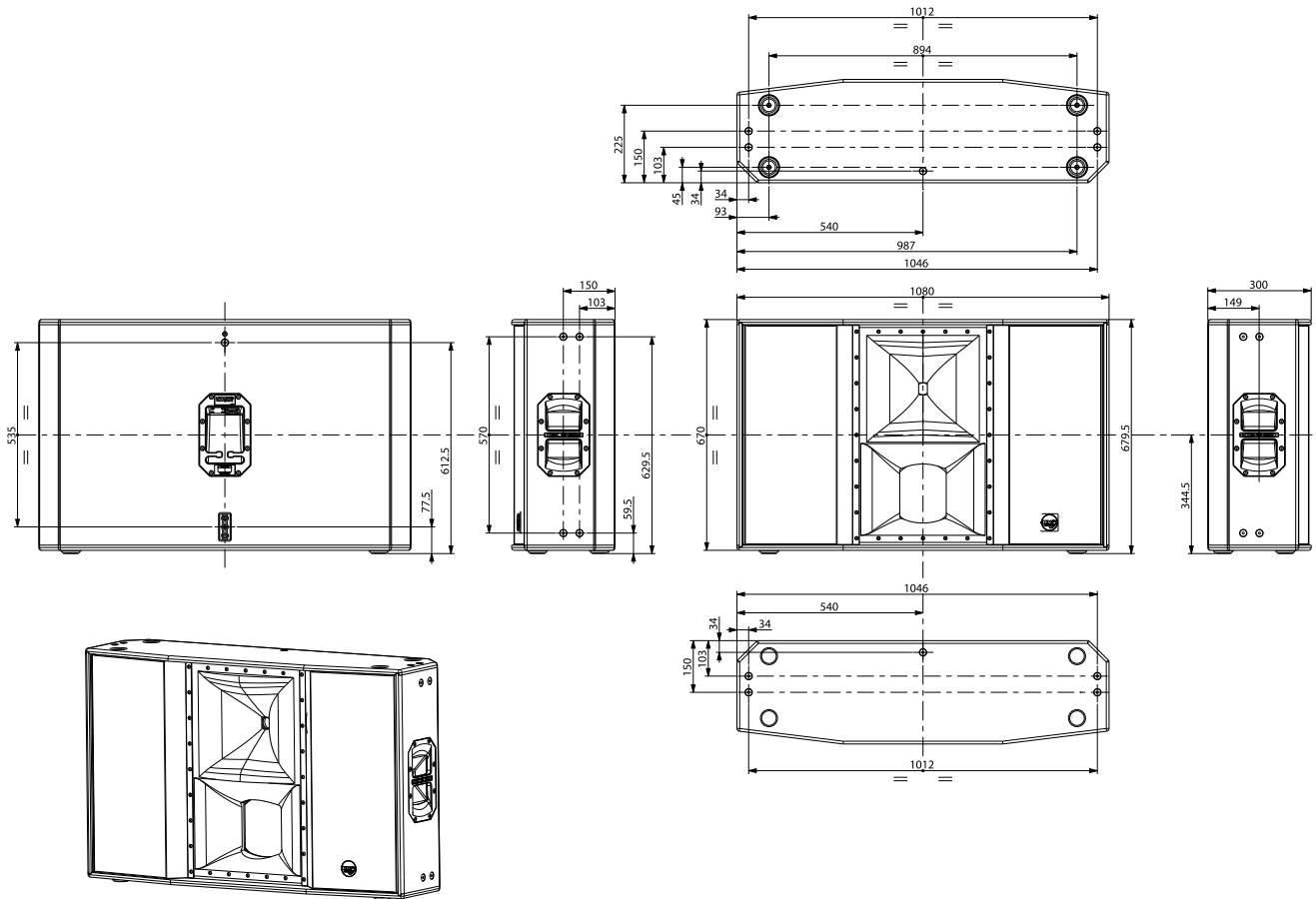

Architects and Engineer's Specifications

The three-way, mid / high loudspeaker system shall incorporate four 12-inch mid-bass (MB) transducer a 8-inch mid range (MR) speaker and a 1.4-inch exit compression driver high frequency (HF) transducer. The LF drivers are direct radiating, tuned for optimum mid-bass response. The HF and MR transducers shall be loaded in constant directivity mid/high horn assembly. The system has a nominal coverage pattern of 110° (horizontal) x 40° (vertical).

The loudspeaker enclosure shall have a slim shape and shall incorporate, two side handles with integrated M10 suspension points, integrated internal braces with total 18 M10 suspension points. The speaker cabinet shall be finished with "Orange peeled" Matt Black paint or any RAL (optionally in a wear resistant polymer coating) and fitted with a weather resistant perforated steel grill.

The system shall receive power from a separate stereo Amplifer SL3000/SL3000D.

Amplifier and controller module SL3000/SL3000D consisting of separate power amplifiers for high, midrange and midbass transducers as well as signal processing including electronic band pass crossovers, limiters, phase alignment, time correction, equalization and speaker protection. The speaker system shall connect to the SL3000/SL3000D via proprietary cables terminated in Amphenol AP-6 connectors. The three-way mid / high loudspeaker system shall be the KV2 Audio SL412.

Specifications

System Acoustic Performance

Max SPL Long-term	134dB
Max SPL Peak	137dB
-3dB Response	70Hz to 22kHz
-10dB Response	58Hz to 22kHz

High Frequency Section

Acoustic Design	Horn Loaded
High Horn Coverage Horizontal / Vertical	110° x 40°
Rotatable Horn	No
High Frequency Amplifier Requirement	100W
Throat Exit Diameter / Diaphragm Size	1.4" / 3"
Diaphragm Material	Nitride Titanium
Magnet Type	Neodymium

Mid Range Section

Acoustic Design	Horn Loaded
Mid Horn Coverage Horizontal / Vertical	110° x 40°
Rotatable Horn	No
Midrange Amplifier Requirement	200W
Woofer Size / Voice Coil Diameter / Design	8" / 3.0" / Trans Coil
Diaphragm Material	Epoxy Reinforced Cellulose
Magnet Type	Neodymium

Low Frequency Section

Acoustic Design	Front Loaded, Bass Reflex
Low Frequency Amplifier Requirement	1000W
Number of Drivers	4
Woofer Size / Voice Coil Diameter / Design	12" / 3" / Inside outside
Magnet Type	Neodymium and Ferrite

Speaker Input

Speaker Input	AP6
---------------	-----

Cabinet

Cabinet Material	Baltic birch
Handles	2
Flyware	20x M10 mounting points
Color	"Orange peeled" Matt Black or any RAL

Physical Dimensions

Height	670 mm (26.38")
Width	1080 mm (42.52")
Depth	300 mm (11.81")
Weight	60 kg (132.28lbs)

The **SL412** is a 3-way high output, active-driven, wide dispersion loudspeaker module. It is designed as part of a sound reinforcement speaker system that includes the SL3000/SL3000D system control and amplification system. The SL412 Loudspeaker system benefits from being designed exclusively to operate above 60Hz. By optimizing the ideal operating band pass of each system component, the SL412 can achieve extremely high output levels consistently and safely.

Active-driven by the SL3000/SL3000D unit

Power, electronic crossovers, phase alignment, equalization, time correction and speaker protection are provided within the SL3000/SL3000D unit. This "one plug in, one-plug-out" system ensures fast, easy set up and complete control. It gives you the benefits of active sound reinforcement technology, yet locates the electronics in an easy access rackmount module. Together, the SL412 and SL3000/SL3000D unit deliver the highest dynamic range of any system currently available, providing new levels of clarity, depth and resolution.

Advanced compression driver

KV2 Audio's transducer partner, 18 Sound in Cavriago, Italy, manufactures and co-develops all SL412 components. The compression driver is a 3-inch nitride- titanium diaphragm design, featuring a complex geometry phase plug that dramatically lowers distortion, eliminates ring modes and provides clearer, ripple free performance.

Mid/High horn design

The SL412 features a mid/high integrated horn design with a number of unique features. The horn design is based on constant directivity geometry with an emphasis on maintaining low transducer compression ratios, high output and wide dispersion (110° x 40°). The midrange speaker is fixed to a large aluminum heat sink which is attached to a precisely designed midrange "chamber". The combination provides optimal cone loading and heat dissipation. Further loading and dispersion is controlled through a precision phase plug.

Heat-resistant midrange

Midrange frequencies between 450Hz and 2.2kHz are reproduced by an eight-inch midrange speaker that provides 106dB of sensitivity (1 watt / 1 meter) when coupled with the integrated horn. The magnetic motor assembly features a Trans Coil 3" diameter voice coil assembly and extensive use of neodymium. Because of the limited linear movement of most midrange transducers - usually 2-3mm - ventilation of the voice coil assembly and magnetic structure is poor and failure rate from heat fatigue is high. The SL412 midrange dissipates heat passively through the use of a massive aluminum heat sink. When combined with the SL3000/SL3000D amplifier unit control electronics, the system provides high output levels safely and consistently over infinite periods of time and dramatically reducing heat associated transducer problems such as power compression and decreased dynamics.

Neodymium mid-bass transducer

The SL412 features a four twelve-inch neodymium mid-bass speakers with front loaded bass reflex design. It is important to note that neodymium is not a transducer panacea, as it cannot safely operate at the same typical operating temperatures ferrite does. Using neodymium requires a profound understanding of material science and finite element analysis to properly design a stable, high force magnetic structure that functions correctly. 18 Sound and KV2 Audio engineering jointly designed the twelve-inch mid-bass driver for the SL412. The SL412 mid-bass transducers reproduces frequencies from 60Hz to 450Hz. Used mid-bass transducers are very precise and fast with high sensitivity. The high efficiency neodymium motor provides an extraordinary amount of force that delivers complete control of the cone mass and a high overall weight loss.

Easy to set up

The SL412 is the ultimate, nice looking enclosure featuring a number of ergonomically designed components that make it a light, small, and easy speaker to set up and use. KV2 designed and tooled new cabinet handles for use in their products. The two side handles make it easy to pick up and reposition the SL412 in a natural, instinctive manner. There are four industrial grade, internal braces placed at each corner and one internal brace on the back. Corner braces are held in places by four M6 and two M10 bolts, the back brace is held by two M6 and one M10, providing a wide range of installation and suspension flexibility.



SL412 rear panel
(cable connection
to SL3000/SL3000D
unit Amplifier/Controller)

Frequency response

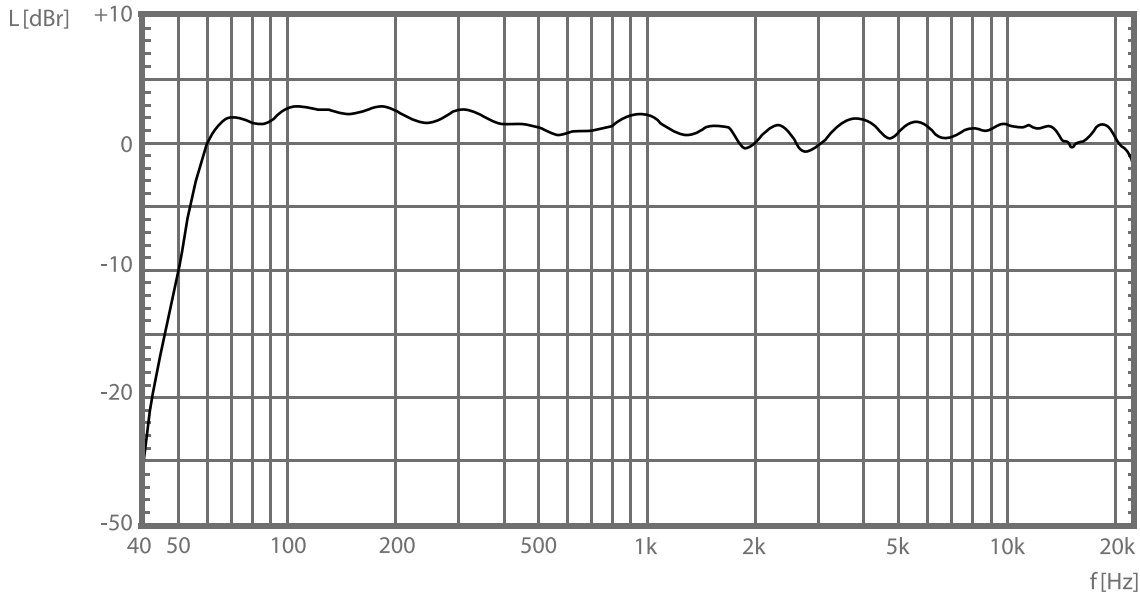

Horizontal Polarplots

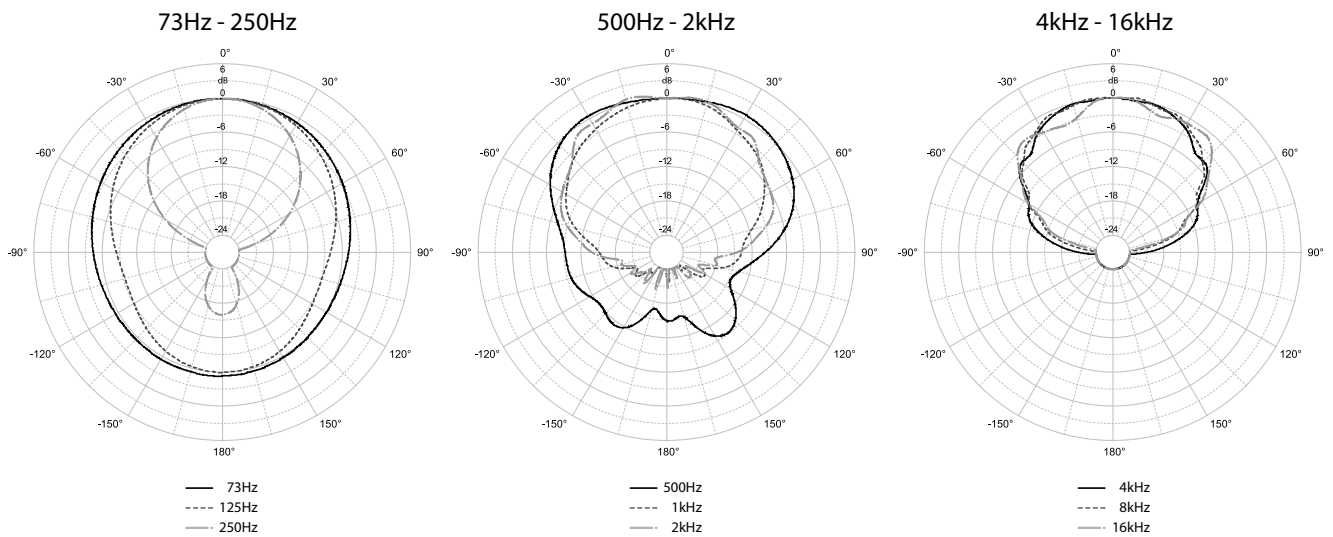

Vertical Polarplots

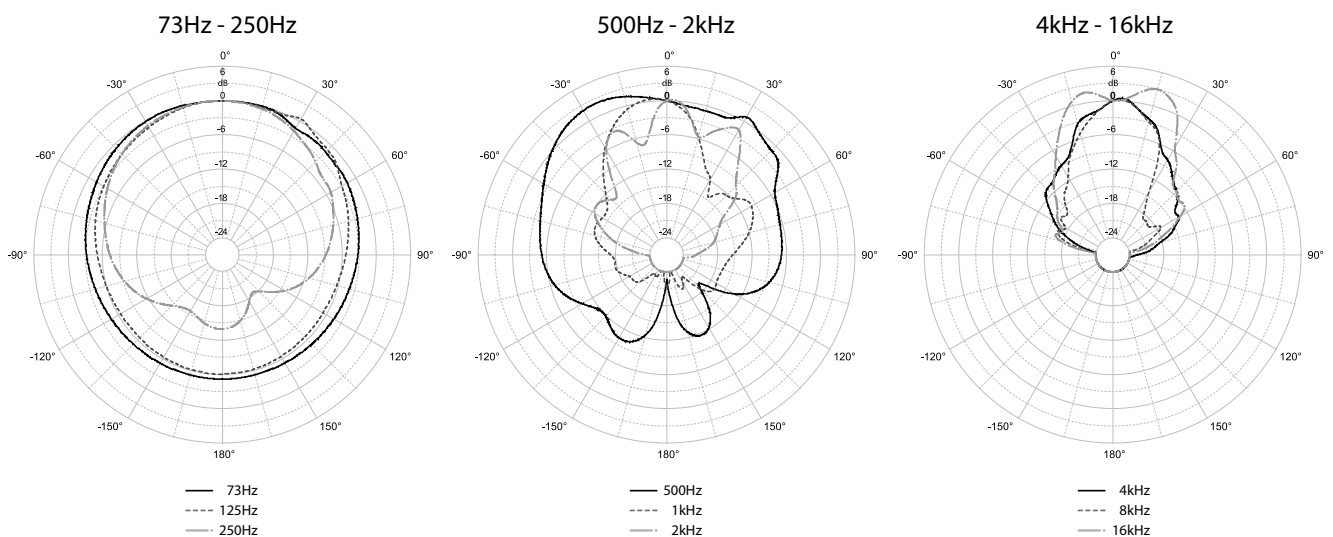

SL412 · Frequency response

SL6.10

BASS MODULE

SL6.10 - part number KVV 987 507



Application

Specifically designed subwoofer enclosure to accompany the SL412 as a high powered aesthetically pleasing-full range music playback and performance system

- Fixed installation
- Nightclubs
- Multi use venues

Introduction

Following on from our successful SL2.15 subwoofer, the latest generation SL sub, the SL6.10 incorporates six 10" directly radiating speakers which radically improve dynamics and definition from the same sized enclosure. Built to integrate aesthetically with the SL412, The SL6.10 produces accurate bass from its slim cabinet design. Bass response is enhanced by coupling or even tripling the cabinets, particularly when the SL6.10 is used against or within a wall, providing optimum output for its compact footprint. It also combines acoustically with the Ultra Low Frequency VHD1.21 and 2.21 subwoofers as part of a five way active driven system.

Features

- Slim, discreetly profiled wall mount cabinet
- 129dB sustained output, 132dB peak with very high dynamic range
- Simple wall mounting, suspension and ground stacking options and can be installed internally into walls and surfaces
- These units can be designed and supplied with custom colors, grill templates and logos, offering a flexible and truly designer integrated product
- A single horizontal yoke assembly with multiple fixed angles and fixing locations, provides a quick and cost effective solution for simple suspension
- Front-loaded, 6x 10" bass drivers with 2" voice coil assembly and ferrite magnetic motor structure
- Professional, exterior-grade Baltic birch construction with "Orange peeled" Matt Black paint or any RAL (optionally in a wear resistant polymer coating)
- Proprietary side handle design for simplified handling and carrying
- Internal back braces with nine M10 suspension points
- A total of 23 suspension points are available for custom installation applications
- Three SL6.10 speakers require one channel of a two channel VHD3200/VHD3200D subwoofer amplifier unit

Drawings

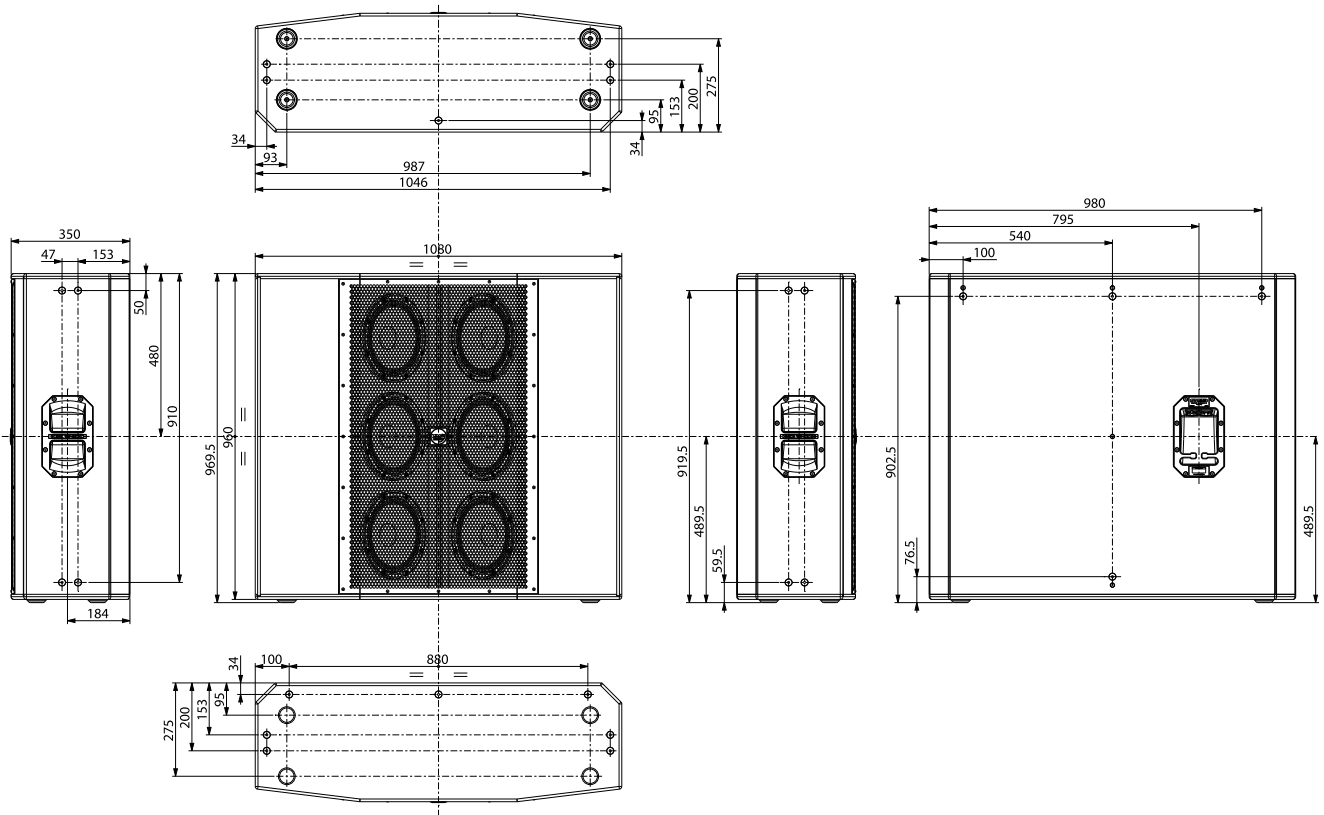

Architects and Engineer's Specifications

The bass module loudspeaker system shall incorporate six 10-inch low frequency (LF) transducer with ferrite motors and 3-inch polyamide, high-temperature voice coils. The LF driver shall be mounted inside a compact wood enclosure with bass reflex design.

The loudspeaker enclosure shall have a slim shape and shall incorporate two side handles with integrated M10 suspension points and incorporate integrated internal braces with 23 M10 suspension points. The speaker cabinet shall be finished with "Orange peeled" Matt Black paint or any RAL (optionally in a wear resistant polymer coating) and fitted with a weather resistant perforated steel grill.

This speaker shall receive power from a separate subwoofer amplifier module (VHD3200/VHD3200D) including speaker protection. The speaker system shall connect to the amplifier module via proprietary cables terminated in Amphenol AP-4 connectors.

Specifications

System Acoustic Performance

Max SPL Long-term	129dB
Max SPL Peak	132dB
-3dB Response	50Hz to 500Hz
-10dB Response	45Hz to 500Hz
Sensitivity	100dB
Impedance	12Ω
Crossover Point	70Hz to 200Hz

Low Frequency Section

Acoustic Design	Direct-Radiating with Bass Reflex
Subwoofer Amplifier Requirement	1800W / 3x SL6.10 (1 ch-VHD3200 amp)
Number of Drivers	6
Woofer Size / Voice Coil Diameter	6x 10" / 2"
Magnet Type	Ferrite
Diaphragm Material	Epoxy Reinforced Cellulose

Speaker Input

Speaker Input	AP4
---------------	-----

Speaker Output

Speaker Output	AP4
----------------	-----

Cabinet

Cabinet Material	Baltic birch
Handles	2
Color	"Orange peeled" Matt Black or any RAL

Physical Dimensions

Height	960 mm (37.8")
Width	1080 mm (42.52")
Depth	350 mm (13.78")
Weight	84 kg (185.2lbs)

The **SL6.10** is a compact, slim cabinet, high output bass module designed as a component of an SL Series sound reinforcement speaker system. The SL6.10 was designed as a direct radiation system with bass reflex, this system provides high output power from a relatively small and very shallow cabinet footprint. It is ideal for use in installation applications that require reproduction of low frequencies with very high transient content and where is no space for large subwoofers cabinets.

Fast and easy setup

Power for the SL subwoofer system is provided from external amplifier VHD3200/VHD3200D, as a crossover and control system is used SL3000/SL3000D Amplifier from ensuring fast, easy set up and complete control. Together with an SL Series Mid High module and an SL3000/SL3000D system, they deliver the very high dynamic range and providing new levels of clarity, depth and resolution.

Durable, high-output low frequency transducers

KV2 Audio's transducer development and manufacturing partner, 18 Sound in Cavriago, Italy, manufactures the woofer for the SL6.10. The device is the result of their state-of-the-art R&D facility and advanced production capabilities. The transducer features a double silicone spider, polyimide voice coil assembly that undergoes multiple baking and curing processes as well as an advanced magnetic structure with advanced cooling system.

Built with load-in and load-out in mind

The SL6.10 is a very compact, slim, lightweight enclosure featuring a number of ergonomically designed parts that make it an easy speaker install and use. SL6.10 uses cabinet handles designed and tooled by KV2 for use in their products. The two side handles make it easy to pick up and reposition in a natural, instinctive manner.

Perfection in the details

The enclosure has four feet made from special acetal copolymer material. This material has two very essential properties that make it ideal for use in this application, high density and a very low coefficient of friction makes cabinet easy to move and slide cabinets with high durability.

Easy to install

There are eight industrial grade, internal braces placed at each corner. Each brace is held in place by four M6 and two M10 bolts providing a wide range of installation and suspension flexibility.



SL6.10 rear panel
(cable connection to VHD3200
unit Amplifier/Controller)

SL3000

VERY HIGH DEFINITION AMPLIFIER

SL3000 - part number KVV 987 280 (250V)
 KVV 987 279 (230V)
 KVV 987 278 (115V)



Application

Specifically designed as the amplification and control elements for the SL loudspeaker systems in a 4RU mount module

- Fixed installation
- Nightclubs
- Multi-use venues
- Large bars

Introduction

The SL3000 Amplifier is a three-way, active control and amplification system specifically designed for the KV2 Audio SL Series modular loudspeaker systems. It houses all signal processing and amplification as well as providing control external subwoofer cabinet to run further subwoofer cabinets if needed. External subwoofer is powered by the external subwoofer amplifier. The SL3000 Stereo Amplifier drives and controls one SL412 per channel and follows the typical KV2 holistic approach of matching components with high quality electronics for true direct performance. All time alignment, phase correction and equalisation is provided onboard.

Features

The amplifier compliment inside the SL3000 Amplifier is as follows:

- High Frequency - 100-watt, Class AB, push pull, low intermodulation design
- Mid Frequency - 200-watt, Class AB, push pull, low intermodulation design
- Bass - 1000-watt, high-efficiency, current-enhancing switch mode technology with Linear Active Filter

Unpacking

Unpack the SL3000 Amplifier and check to see if there is any damage to it. If you find any damage notify your supplier immediately. Only the consignee may institute a claim with the carrier for damage incurred during shipping. Be sure to save the carton and all packing materials for the carrier's inspection. Should you ever need to ship the unit, only use the original factory packaging. If the shipping carton is unavailable, contact your supplier to obtain a replacement.

The SL3000 Amplifier carton should contain:

- SL3000 Amplifier control unit
- User guide
- Two PowerCon detachable power cables

Amplifier rack mounting

The SL3000 Amplifier will mount in standard 19" rack systems. Integral rear mounting rack ears are also provided for additional support, do not rely on fixing and mounting the amplifier using just the front panel as support. Use eight screws and washers to mount the amplifier to the equipment rack rails. We recommend using a shock mounted rack for touring use to prolong the life of your amplifier.

Drawings

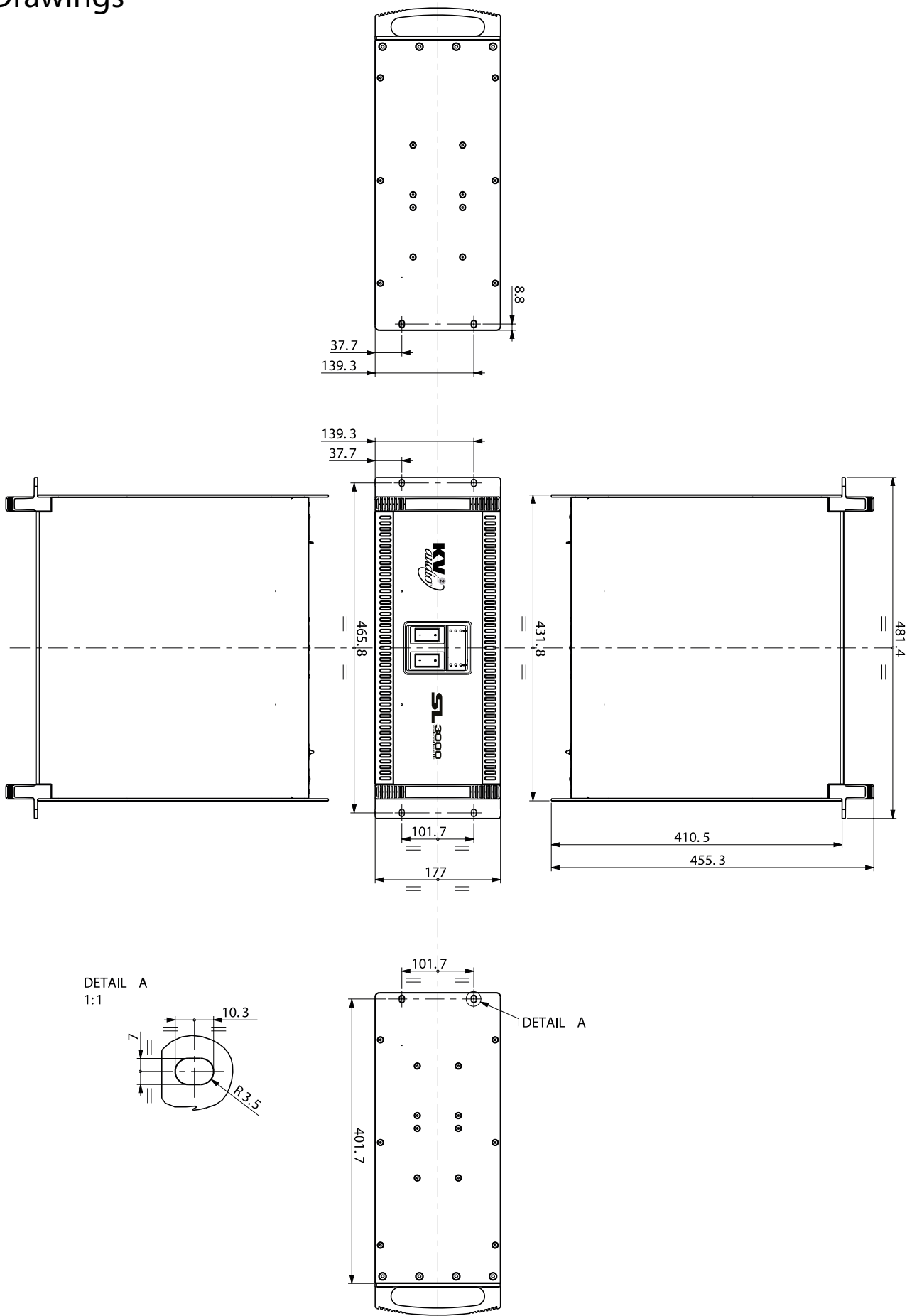

Cooling

The SL3000 Amplifier have a comprehensive cooling system featuring chassis sealed PCB board mounting and shock mounted, speed controlled fans. This means that the cooling system never drives air across PCB boards, connectors or components, ensuring prolonged electronic component lifespan and minimizing maintenance cycles.

Air is drawn into the front of the amplifier by the two fans on the rear panel, this passes over the cooling fans of the heat sinks and exhausts through the rear. If the heat sink gets too hot, its sensing circuit will open the output relay, disconnecting the load.

It is important to have an adequate air supply at the front of the amplifier, and enough space around the rear of the amplifier to allow the cooling air to escape. If the unit is rack mounted, do not use doors or covers on the rear of the rack, the exhaust air must flow without restriction. If you are using racks with closed backs, use fans on the rear rack panel to ensure an ample air supply.

The filters at the top and bottom of the front panel must be kept clean and free of dust and dirt to allow full operation-CHECK PERIODICALLY.

AC Requirements

Two PowerCon cables are provided to connect the SL3000 Amplifier to a suitable AC power supplies. Each cable powers each separate amplifier channel for sufficient current delivery.

The SL3000 requires a ground connection. Always use a grounded outlet and plug.

The PowerCon is a connector without breaking capacity, i.e. the PowerCon should not be connected or disconnected under load or while it is live. Always isolate your AC supply before disconnecting the PowerCon connector.

The SL3000 amplifier operates in either 115V, 230V or 250V modes. Although pre-configured at the factory, the unit's operating voltage mode can be changed in the field. Amplifier power plug must remain readily operable.

Your amplifier will be supplied preset to the voltage used in your area. The table below provides typical current draw figures for the SL3000 Amplifier.

The receptacle must be connected to a fuse or circuit breaker. Connection to any other type of receptacle poses a shock hazard and may violate local electrical codes.

Do not allow water or any foreign object to get inside the amplifier. Do not put objects containing liquid on or near the unit. To reduce the risk of overheating the amplifier, avoid exposing it to direct sunlight. Do not install the unit near heat-emitting appliances, such as a room heater or stove. This amplifier contains potentially hazardous voltages. Do not attempt to disassemble the unit. The unit contains no user serviceable parts, repairs should be performed only by factory trained service personnel.

AC Input	Current draw with amplifier running at Average Power (Each Channel)	Current draw with amplifier running at Peak Power (Each Channel)
250V	3.2A	5A
230V	3.5A	5.4A
115V	7A	11A

Current draw of SL3000 Amplifier

Front panel

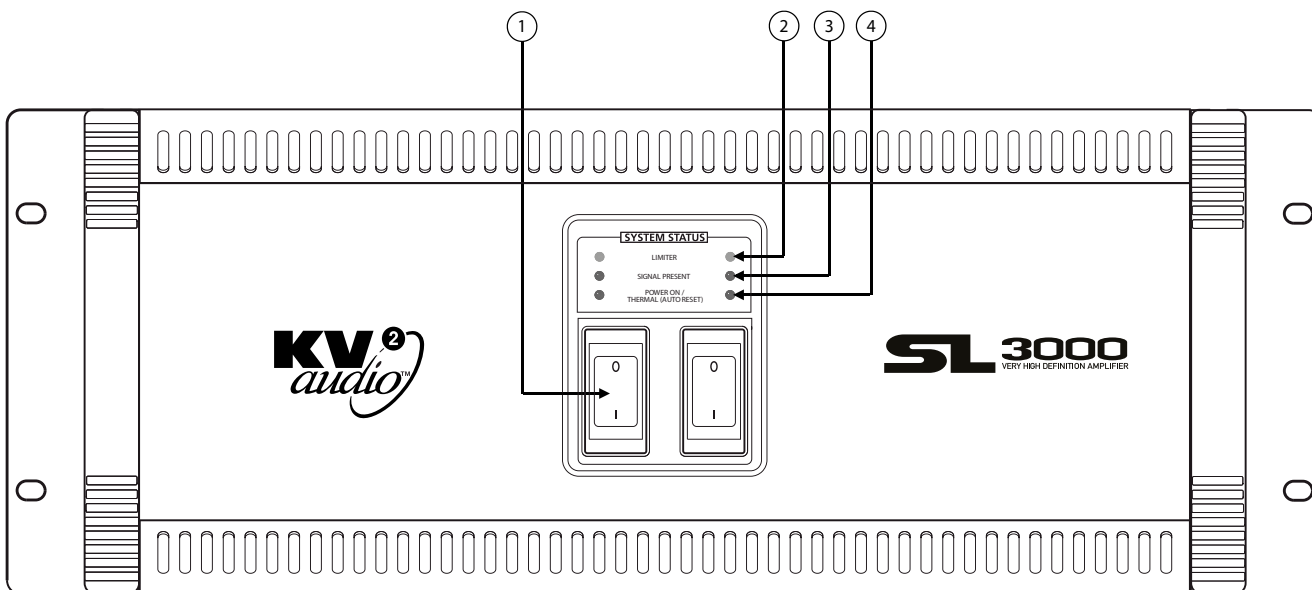

1) AC Mains Switch

The SL3000 Amplifier has a combination AC Main switch/circuit breaker on the front panel. If the switch shuts off during normal use, push it back to the ON position once. If it will not stay on you should take the unit to qualified service personnel to have it serviced.

2) Limiter

Yellow LED, indicates that the audio limiter has been activated. This RMS limiter protects speakers against overload.

3) Signal Present

Green LED indicates when audio signal is present at the amplifier input.

4) Power On / Thermal (Auto reset)

Green LED indicates that the AC power is on. When red, it indicates that the thermal limit of the SL3000 Amplifier has been exceeded and the unit has shut down.

Rear panel

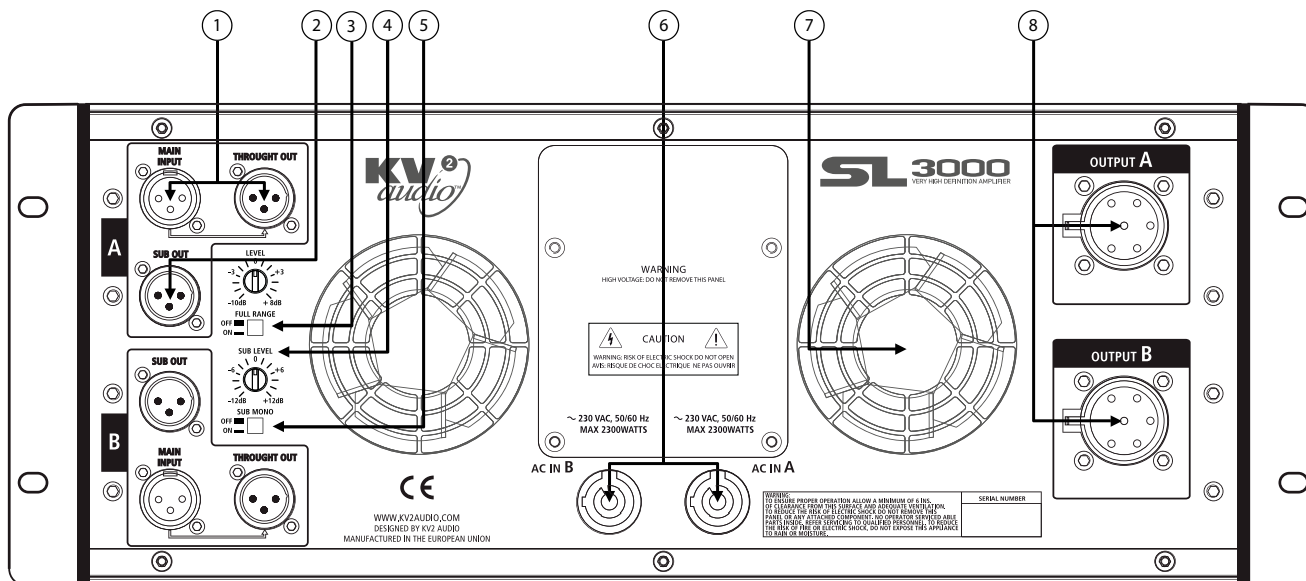

1) Main Input / Throught out

This is the main system input balanced XLR connector with associated Through Signal Output connector for sending unprocessed signal to other devices in a system.

2) Sub out

Balanced XLR output connector, used to connect additional subwoofer. Output is active even when FULL RANGE switch is ON.

3) Full Range

Switch, selects the amplifier crossover setup, when ON full range signal is reproduced by Classic cabinets, when OFF signal is by frequency band in conjunction with the subwoofer output setup.

4) Sub level

This is the level control for the External Sub output in the range -6 to +6 dB.

5) Mono

Switch, sets SUB OUT outputs summing SUB OUT outputs channel A and B together.

6) PowerCon Power Connectors

The SL3000 Amplifier uses two connectors per two channel. Each connector supplies one channel. They accept standard PowerCon terminated AC Mains cables.

7) Fans

The cooling fans operate continuously while the amplifier is on. An internal temperature sensor increases the speed of the fans during high temperature conditions. Air enters through the front grille and exits through the rear. Be sure to allow adequate air flow to the front of the rack in which the SL3000 Amplifier is mounted.

8) Speaker AP6 Connectors

Accepts a standard AP6 terminated loudspeaker cable for connecting up to a single SL412 cabinet. We recommend using 2.5mm/core cables..

Full range setup

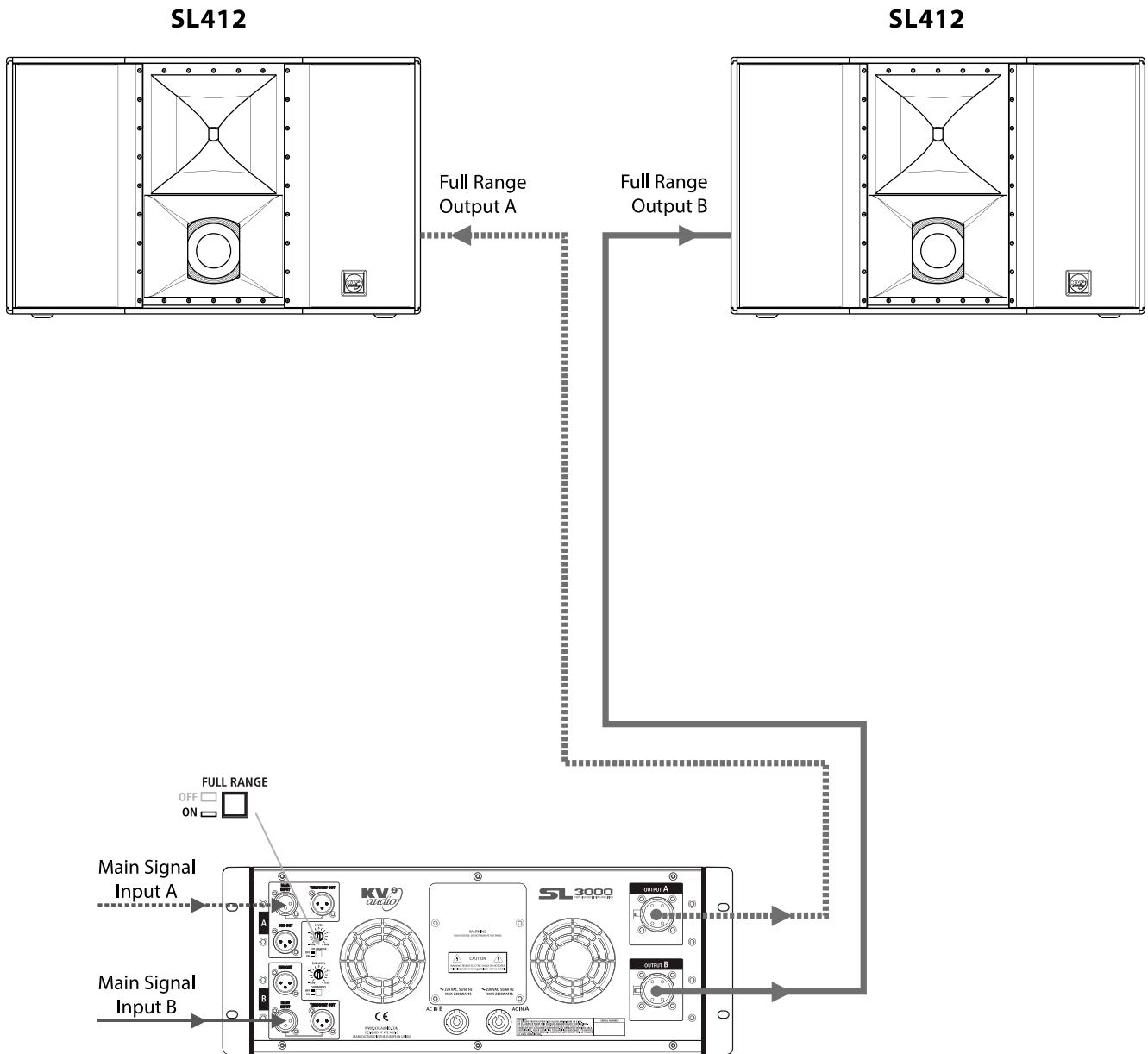

Set SL3000 Amplifier to FULL RANGE ON mode. SL412 cabinets plays full range signal.

External subwoofer setup

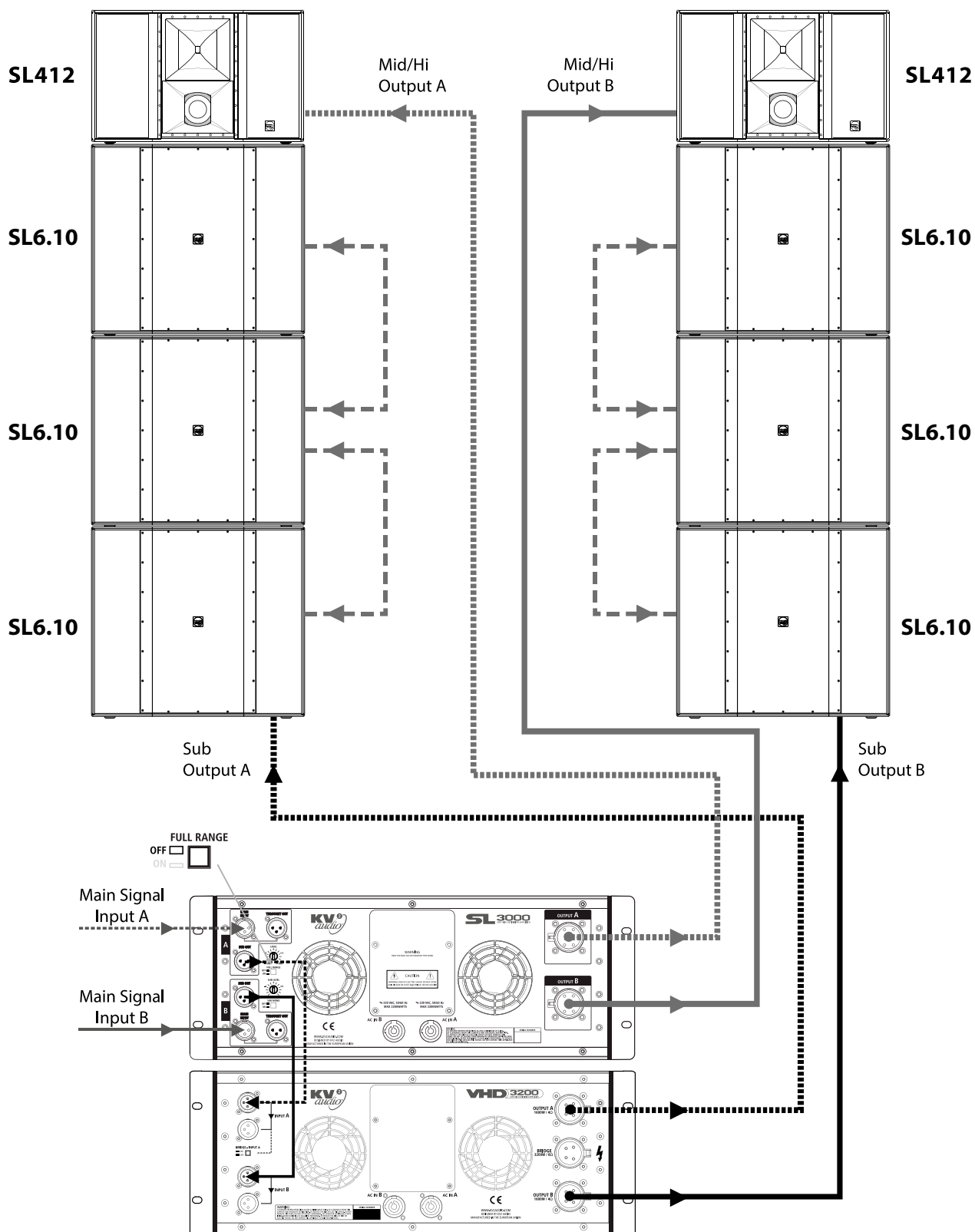

Set SL3000 Amplifier to FULL RANGE OFF mode. Signal is crossed over at Hi/Mid for SL412 cabinets and SUB for external subwoofer.

SUB SET UP LEVEL setting depends on which subwoofer unit is used.

SL3000 · Using the system

Specifications

Output Channels

Number of Channels	2 (stereo)
Total Output Power	2x 1300W

High Frequency Amplifier Specification

Type	Class AB - Push Pull - Low IM Design, Transformer balanced output
Rated Continuous Power	100W
Distortion	<0.02%
Operating Bandwidth	2,5kHz to 40kHz

Mid Frequency Amplifier Specification

Type	Class AB - Push Pull - Low IM Design, Transformer balanced output
Rated Continuous Power	200W
Distortion	<0.02%
Operating Bandwidth	400Hz to 2,5kHz

Low Frequency Amplifier Specification

Type	High efficiency, Current-enhancing switch mode
Rated Continuous Power	1000W
Distortion	<0.02%
Operating Bandwidth	35Hz to 400Hz

Signal Input

Input Sensitivity	1V RMS
Input Impedance	20kΩ (balanced)

Speaker Output

Speaker Output	2x AP6
----------------	--------

Power

Power Connector	2x Neutrik PowerCon®
Operating Voltage	115V / 230V / 250V
Operating Voltage Range	100 to 120V@60Hz 205 to 240V@50Hz 225 to 260V@50Hz
Recommended Amperage	2x10A 115V 2x5A 230V 2x5A 250V

Physical Dimensions

Height	177.8 mm (7.0"), 4RU
Width	481.4 mm (18.95")
Depth	495 mm (19.5")
Weight	39.2 kg (86.62lbs)

Block Diagram

Channel A, channel B is identical

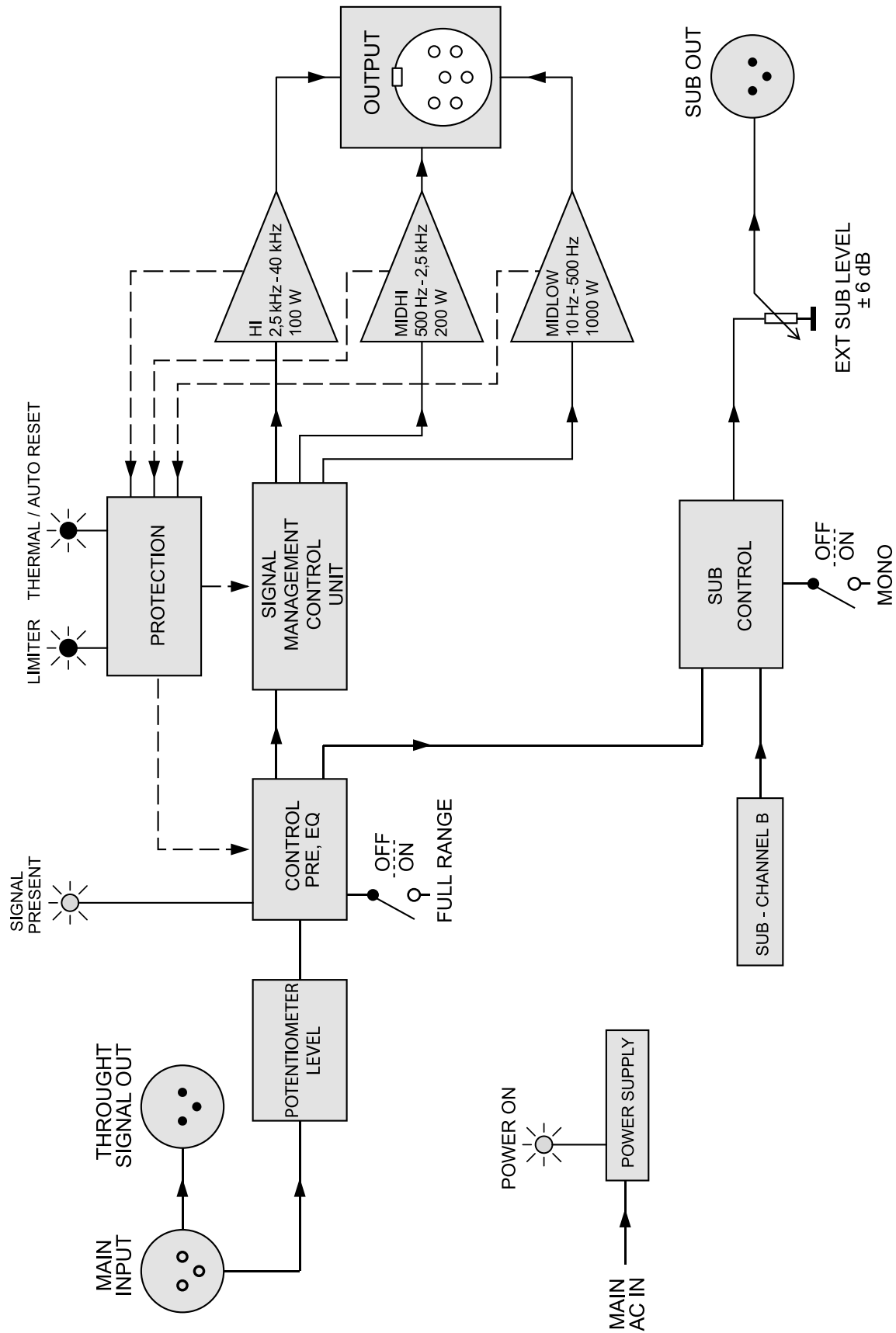

Mid/Hi speaker cable MH60

part name:
Cable MH60
 part number:
KVV 987 125
description:
 - 6 wire speaker cable
 - AP6 connectors
 - 6m (20ft)
 - for Mid/Hi Module hook-up



Mid/Hi speaker cable MH120

part name:
Cable MH120
 part number:
KVV 987 126
description:
 - 6 wire speaker cable
 - AP6 connectors
 - 12m (40ft) length
 - for Mid/Hi Module hook-up



Mid/Hi speaker cable MH180

part name:
Cable MH180
 part number:
KVV 987 127
description:
 - 6 wire speaker cable
 - AP6 connectors
 - 18m (60ft) length
 - for Mid/Hi Module hook-up



Bass speaker cable LF15

part name:
Cable LF15
 part number:
KVV 987 121
description:
 - 4 wire speaker cable
 - AP4 connectors
 - 1,5m (5ft)
 - for Bass Module daisy-chaining



Bass speaker cable LF40

part name:
Cable LF40
 part number:
KVV 987 122
description:
 - 4 wire speaker cable
 - AP4 connectors
 - 4m (13ft)
 - for Bass Module hook-up



Bass speaker cable LF100

part name:
Cable LF100
 part number:
KVV 987 123
description:
 - 4 wire speaker cable
 - AP4 connectors
 - 10m (33ft)
 - for Bass Module hook-up



Bass speaker cable LF200

part name:
Cable LF200
 part number:
KVV 987 124
description:
 - 4 wire speaker cable
 - AP4 connectors
 - 20m (66ft)
 - for Bass Module hook-up



Cable KIT

part name:
Cable KIT
 part number:
KVV 987 047
description:
 - consist of four
 high-quality Amphenol
 AP cable assemblies
 - 2 pcs LF15
 - 1pc LF40
 - 1pc MH60



Speaker cables

part name:
1m - round flexible speaker cable,
cross section 6 x 2.5mm
 part number:
 - **WX 004**

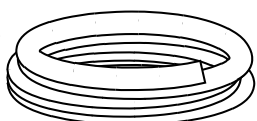

part name:
1m - round flexible speaker cable,
cross section 4 x 2.5mm
 part number:
 - **WX 003**

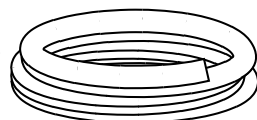

Fly Bar for SL systems

part name:
VB - SL412
 part number:
KVV 987 293
description:
 - 4 pcs Quick-lock-pins
 6mm included
 - 4 pcs M10 hex screws
 with hole included

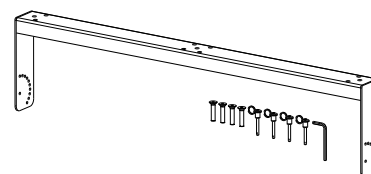

SL Ground Stack

part name:
SL GROUND STACK

part number:
KVV 987 320

description:

- 6 pcs M10 hex screws with hole included
- 6 pcs Quick-lock-pins 6mm included
- 2pcs knob with screw included
- 1pc allen key - 6mm included

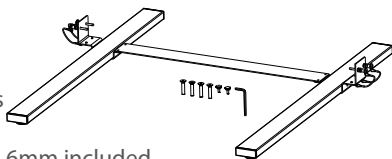

Flybar for SL412

part name:
Flybar SL412

part number:
KVV 987 331

description:

- 2 pcs T-grip M10x30m included
- 2 pcs Quick-lock-pins 6mm included
- 2 pcs M10 hex screws with hole included
- 1 pc allen key - 6mm included

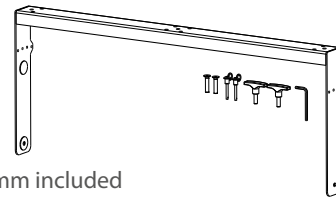

SL Top Bracket kit with screws

part name:
SL Top Bracket - screws

part number:
KVV 987 300

description:

- 7 pcs M10 hex screws included
- 1pc allen key - 6mm included



SL Top Bracket kit with Quick-lock pins

part name:
SL Top Bracket - Quick pins

part number:
KVV 987 312

description:

- 7 pcs M10 hex screws included
- 6 pcs Quick-lock-pins 6mm included
- 1pc allen key - 6mm included



SL Sub Bracket kit with screws

part name:
SL SUB Bracket SL2.15

part number:
KVV 987 299

description:

- for joining SL2.15s or SL6.10s
- 9 pcs M10 hex screws included
- 1pc allen key - 6mm included



SL Sub Bracket kit with Quick-lock pins

part name:
SL SUB Bracket

part number:
KVV 987 341

description:

- for joining SL2.15s or SL6.10s
- 9 pcs M10 hex screws with hole included
- 8 pcs Quick-lock-pins 6mm included
- 1pc allen key - 6mm included



Double SL Bracket

part name:
Double SL Bracket

part number:
KVV 987 464

description:

- Bracket for deployment of two suspended SL412 with correct aperture angles

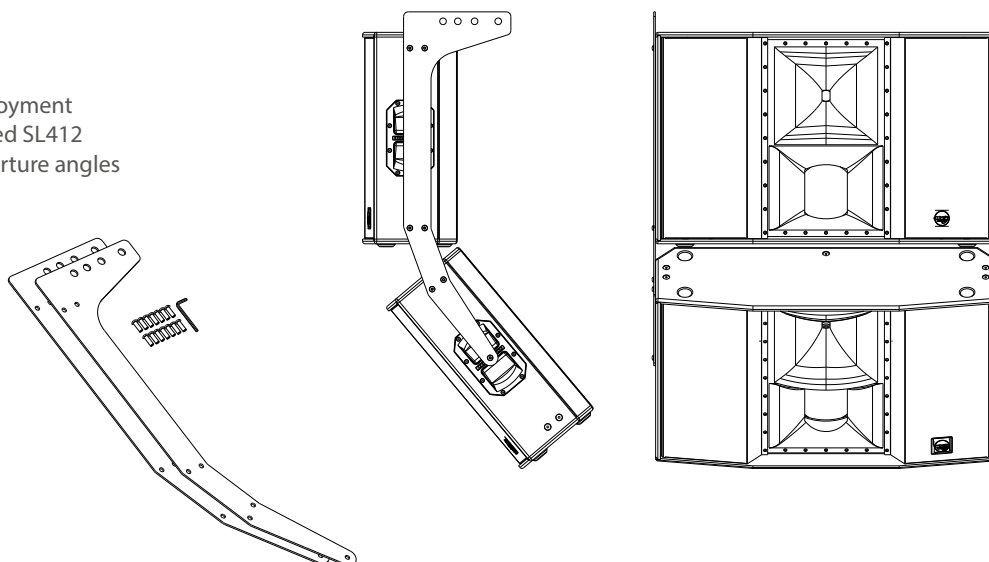

SL Sub / SL412 bracket

part name:

SL Sub / SL412 bracket

part number:

KVV 987 515

description:

- Bracket for deployment of one suspended SL2.15 or SL6.10 and one SL412

*Note: Special request order

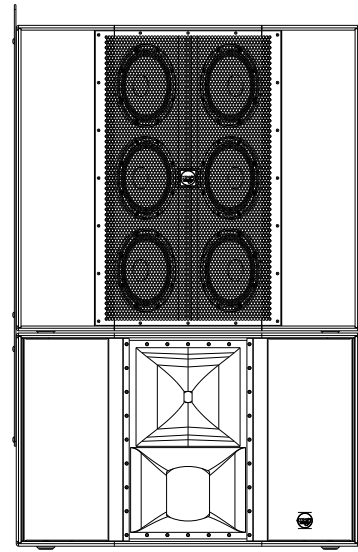
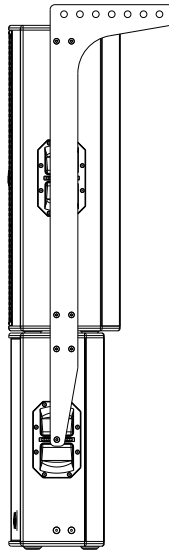
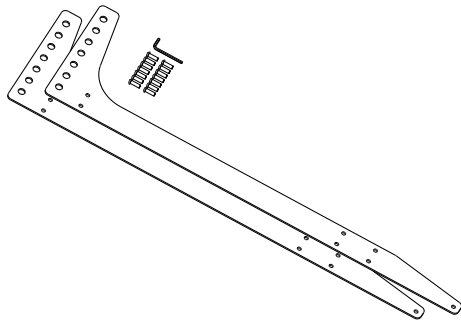

Amphenol AP6 connector

part name:

AP-6-11

part number:

KA 031

description:

- female
- cable mount



Amphenol AP6 connector

part name:

AP-6-12

part number:

KA 033

description:

- male
- cable mount



Amphenol AP4 connector

part name:

AP-4-11

part number:

KA 030

description:

- female
- cable mount



Amphenol AP4 connector

part name:

AP-4-12

part number:

KA 032

description:

- male
- cable mount



SL - Full range mode

Description

- Stereo system requires:
1x SL3000 - stereo amplifier
- Up to 1000 people
- Number of bass cabinets and SUB LEVEL setup - depends on the style of music

Products:

Count	Product
2	SL412
1	SL3000/SL3000D

Accessories:

Count	Accessory Title
2	Cable MH120

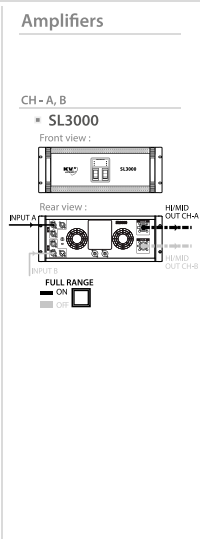
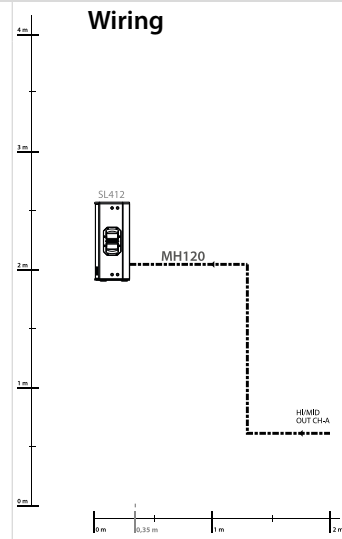
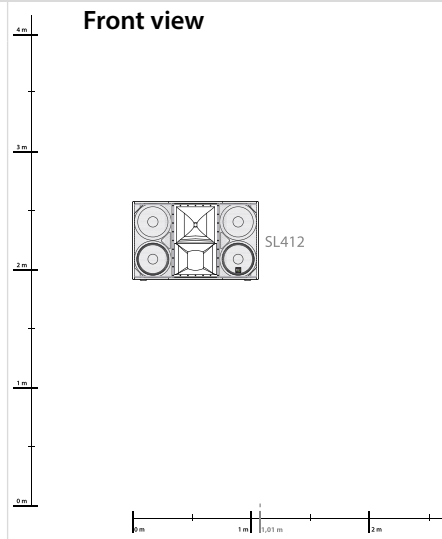

SL - Configuration A

Description

- Stereo system requires:
1x SL3000 - stereo amplifier
1x VHD3200 - sub amplifier
- Up to 2000 people
- Number of bass cabinets and SUB LEVEL setup - depends on the style of music

Products:

Count	Product
2	SL412
4	SL6.10
1	SL3000/SL3000D
1	VHD3200/VHD3200D

Accessories:

Count	Accessory Title
2	Cable MH120
2	Cable LF15
2	Cable LF40
2	SL Sub Bracket kit with Quick-lock pins
2	SL Top Bracket kit with Quick-lock pins

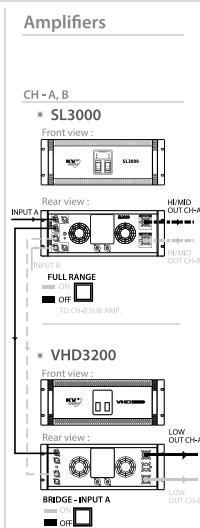
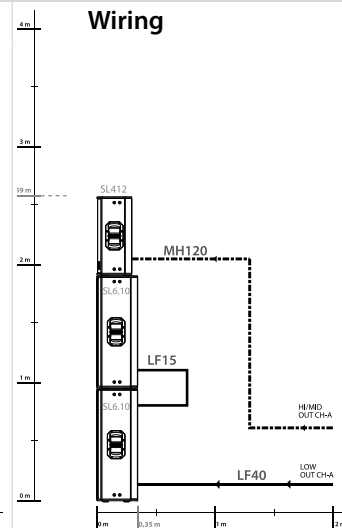
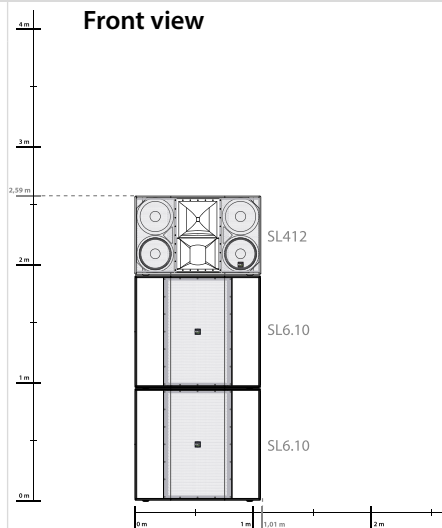

SL - Configuration B1

Description

- Stereo system requires:
1x SL3000 - stereo amplifier
1x VHD3200 - sub amplifier
- Up to 2000 people
- Number of bass cabinets and SUB LEVEL setup - depends on the style of music

Products:

Count	Product
2	SL412
6	SL6.10
1	SL3000/SL3000D
1	VHD3200/VHD3200D

Accessories:

Count	Accessory Title
2	Cable MH120
2	Cable LF40
4	Cable LF15
2	SL Sub Bracket kit with Quick-lock pins
4	SL Top Bracket kit with Quick-lock pins

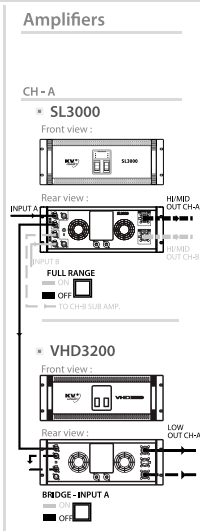
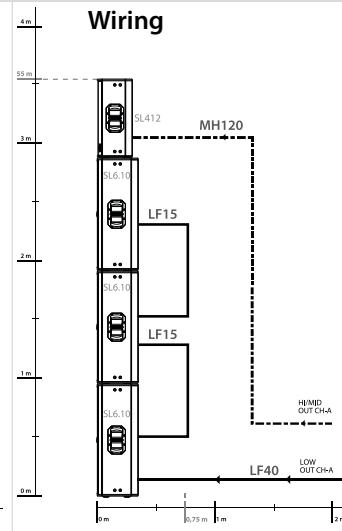
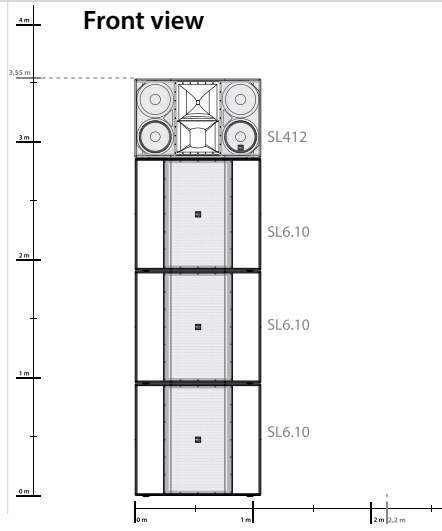

SL - Configuration B2

Description

- Stereo system requires:
1x SL3000 - stereo amplifier
1x VHD3200 - sub amplifier
- Up to 2000 people
- Number of bass cabinets and SUB LEVEL setup - depends on the style of music

Products:

Count	Product
2	SL412
6	SL6.10
1	SL3000/SL3000D
1	VHD3200/VHD3200D

Accessories:

Count	Accessory Title
2	Cable MH120
2	Cable LF40
4	Cable LF15
2	SL Sub Bracket kit with Quick-lock pins
4	SL Top Bracket kit with Quick-lock pins

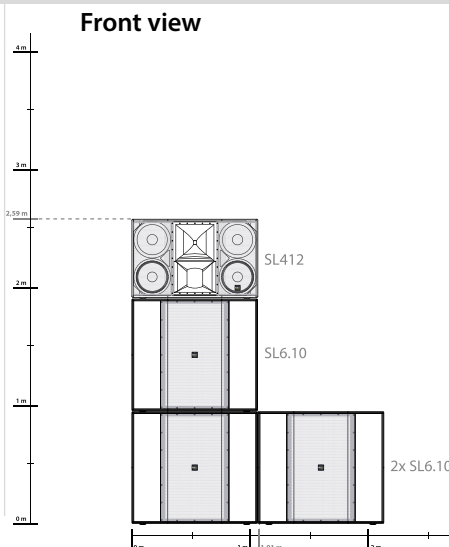

Wiring

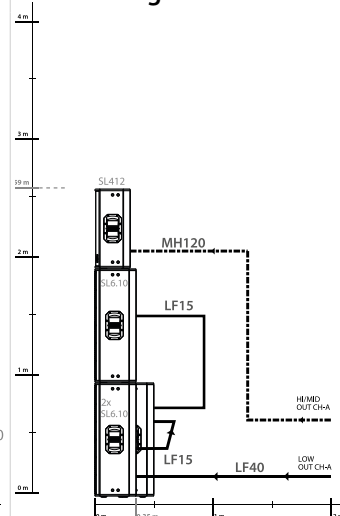

Amplifiers

CH - A, B

SL3000

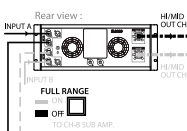

VHD3200

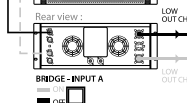

SL - Configuration C

Description

- Stereo system requires:
1x SL3000 - stereo amplifier
2x VHD3200 - sub amplifier
- Up to 2000 people
- Number of bass cabinets and SUB LEVEL setup - depends on the style of music

Products:

Count	Product
2	SL412
8	VHD4.18
1	SL3000/SL3000D
2	VHD3200/VHD3200D

Accessories:

Count	Accessory Title
2	Cable MH120
4	Cable LF15
4	Cable LF40

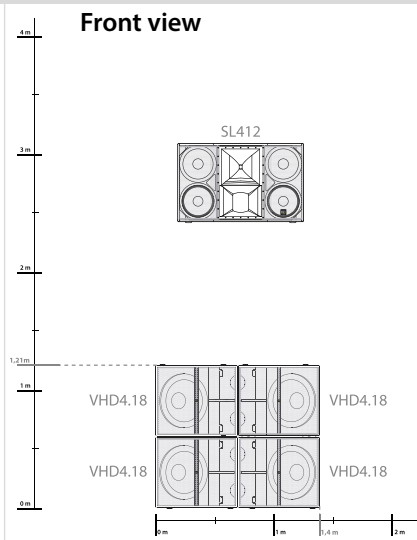

Wiring

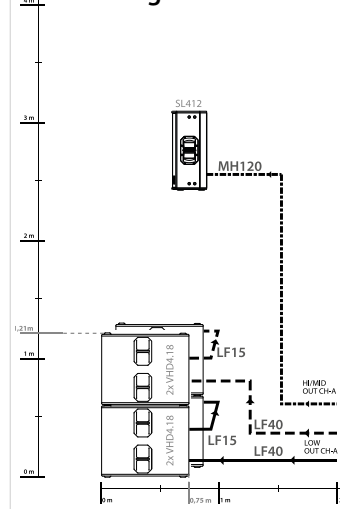

Amplifiers

CH - A

SL3000

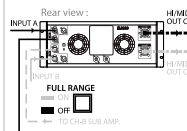

VHD3200

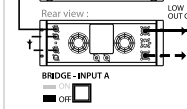

SL - Configuration D

Description

- Stereo system requires:
1x SL3000 - stereo amplifier
2x VHD3200 - sub amplifier
- Up to 2000 people
- Number of bass cabinets and SUB LEVEL setup - depends on the style of music

Products:

Count	Product
2	SL412
2	VHD2.21
1	SL3000/SL3000D
2	VHD3200/VHD3200D

Accessories:

Count	Accessory Title
2	Cable MH120
2	Cable LF40

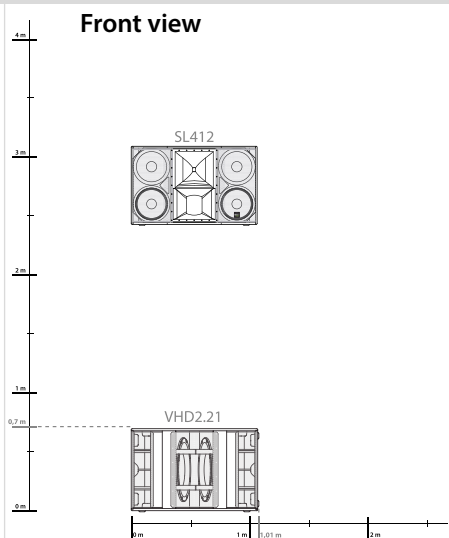

Wiring

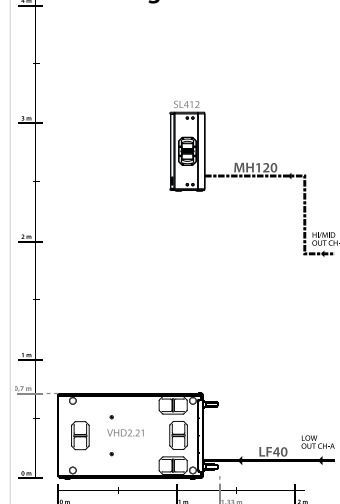

Amplifiers

CH - A

SL3000

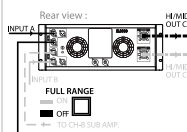

VHD3200

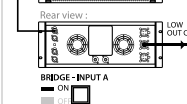

Warranty

Your SL Series is covered against defects in material and workmanship.

Refer to your supplier for more details.

Service

In the unlikely event that your SL Series develops a problem, it must be returned to an authorised distributor, service centre or shipped directly to our factory. Because of the complexity of the design and the risk of electrical shock, all repairs must be attempted only by qualified technical personnel.

If the unit needs to be shipped back to the factory, it must be sent in its original carton. If improperly packed, the unit may be damaged.

To obtain service, contact your nearest KV2 Audio Service Centre, Distributor or Dealer.



The Future of Sound.
Made Perfectly Clear.

KV2 Audio International

Nádražní 936, 399 01 Milevsko
Czech Republic

Tel.: +420 383 809 320

Email: info@kv2audio.com

www.kv2audio.com

KVV120160-00-01-0