



EPAK2500

User Guide



The Future of Sound. Made Perfectly Clear.

At KV2 Audio our vision is to constantly develop technologies that eliminate distortion and loss of information providing a true dynamic representation of the source.

Our aim is to create audio products that absorb you, place you within the performance and deliver a listening experience beyond expectations.

Important Safety Instructions

Before using your EPAK2500, be sure to carefully read the applicable items of these operating instructions and the safety suggestions.

1. Read all product instructions.
2. Keep printed instructions, do not throw away.
3. Respect and review all warnings.
4. Follow all instructions.
5. Do not use this unit near water, in unprotected out door areas or in rain or wet conditions.
6. Clean only with dry cloth.
7. Do not block any ventilation openings.
8. Install in accordance with KV2 Audio's recommended installation instructions.
9. Do not install near any heat sources such as heat radiators, heat registers, stoves or other apparatus that produce heat.
10. Do not defeat the safety purpose of the grounding type plug. A grounding type plug has two blades and a third grounding connector. The third connector is provided for your safety. If the provided plug does not fit into your outlet, consult an electrician for replacement of the obsolete outlet.
11. Do not use this EPAK2500 if the power cable is broken or frayed. Protect the power cable from being walked upon or pinched particularly at the plugs and the point where it exits from the apparatus.
12. Only use accessories specified by KV2 Audio.
13. Follow the mounting instructions.
14. Unplug this unit during lightning storms or when unused for long periods of time.
15. Do not connect an EPAK2500 output in parallel or series with any other EPAK2500's output. Do not connect the EPAK2500 output to any other voltage source, such as battery, mains source, or power supply, regardless of whether the EPAK2500 is turned on or off.
16. Refer all servicing to qualified service personnel. Servicing is required when the EPAK2500 has been damaged in any way, such as when the power-supply cord or plug has been damaged; liquid has been spilled or objects have fallen into the EPAK2500; rain or moisture has entered the unit; the unit has been dropped; or when for undetermined reasons the unit does not operate normally.
17. Do not remove covers. Removal of the cover will expose hazardous voltages. There are no user serviceable parts inside and removable may void the warranty.
18. An experienced user shall always supervise this professional audio equipment.

**CAUTION: TO REDUCE THE RISK OF ELECTRIC SHOCK, DO NOT REMOVE THE COVER.
NO USER-SERVICEABLE PARTS INSIDE. REFER SERVICING TO QUALIFIED PERSONNEL.**

WARNING: To prevent fire or electric shock, do not expose this equipment to rain or moisture.

Contents

Introduction	3
Introduction	3
Getting Started	4
Unpacking	4
Mounting	4
AC Power Requirements	4
Voltage Requirements	4
Cooling	4
Features	5
Upper Panel	5 - 6
Bottom Panel	7
Using the system	8
Normal set up	8
Using the subwoofer insert	9
EPAK2500 Dimensions	9
Block Diagram	10
Specification	11
Accessories	12
Warranty · Service	13
Notes	14 - 16

EPAK™ 2500 Electronic Control & Amplification System

EPAK2500 - part number KVV 987 134 (250V)
KVV 987 000 (230V)
KVV 987 001 (115V)



Application

Specifically designed as the amplification and control elements for ES loudspeaker systems

- Portable PA
- Fixed Installations
- Bars and Nightclubs
- Houses of worship

Introduction

The EPAK2500 is a four-way, active control and amplification system specifically designed for the KV2 Audio ES Series™ modular loudspeaker systems. It houses all signal processing and amplification as well as providing control for six different subwoofer cabinet

configurations, powered by the internal subwoofer amplifier, along with providing control signal to an external subwoofer amplifier to power further subwoofer cabinets if needed.

Unlike most other speaker manufacturers, KV2 Audio is equally expert in electronic design - in fact, we're fifty-year veterans at building rugged, high-current power amps. When you're able to perfectly match an amp with a transducer, you unlock incredible performance that is impossible with passive systems. The amplifier can perfectly handle the impedance swings of the transducer. It can deliver exactly the right amount and type of power. Reliability goes up dramatically as does sound quality. Each amplifier in the EPAK2500 perfectly compliments the transducers it's coupled to. They are therefore very different from each other with respect to construction and purpose.

Mid / High Amplifiers. Both the mid and high frequency amplifiers inside the EPAK2500 are Class AB, Push-Pull amplifier circuits using (MOSFET) Transistors output stage devices. The entire performance strategy for this type of design is based on producing the lowest inter-modulation distortion possible and the highest audio quality in the critical mid and high operating bands. Both amplifiers are coupled to the mid/high drivers through transformer balanced speaker outputs.

Mid Bass and Low Frequency Amplifiers

For these frequency ranges, we've selected a very high efficiency and refined low frequency amplifier topology. The unique part of the design is in the voltage amplifier's ideal method in supplying current to the output stage. It's based on a switcher design that supplies current both in its on and off position and superior bass reproduction quality. The system is also 95% efficient lowering typical amplifier losses and eliminating the need for forced cooling systems.

The amplifier compliment inside the EPAK2500 is as follows:

- High Frequency - 100-watt, Class AB, push pull, low intermodulation design.
- Mid Frequency - 200-watt, Class AB, push pull, low intermodulation design.
- Mid Bass - 600-watt, high efficiency, current-enhancing switch mode with Linear Active Filter.
- Subwoofer - 1600-watt, high efficiency, current-enhancing switch mode with Linear Active Filter.

Robust mechanical design

The EPAK2500 is enclosed in a road-rugged case with two corner handles, aluminium corners and edges cover.

Case has removable front panel with built-in cable storage compartment.



Unpacking

Unpack the EPAK2500 and check to see if there is any damage to it. If you find any damage notify your supplier immediately. Only the consignee may institute a claim with the carrier for any damage incurred during shipping. Be sure to save the carton and all packaging materials for the carrier's inspection.

Should you ever need to ship the unit, only use the original factory packaging. If the shipping carton is unavailable, contact your supplier to obtain a replacement.

The EPAK2500 carton should contain:

- EPAK2500 Amplifier unit
- User's Guide
- PowerCon detachable power cable
- ES Cable Kit - KVV987047 (contains 2pcs LF15, 1pc LF40, 1pc MH60 cables)

Mounting

For additional reliability, the amplifier unit is mounted on a suspension system that isolates it from the shocks and impacts typically encountered on the road. For installations, use the EPAK2500 Wall mounting kit - KVV987024.

AC Power Requirements

The EPAK2500 uses a standard PowerCon AC connector. The device must be connected to a suitable mains socket outlet with protective earthing connection.

THE POWERCON IS A CONNECTOR WITHOUT BREAKING CAPACITY, I.E. THE POWERCON SHOULD NOT BE CONNECTED OR DISCONNECTED UNDER LOAD OR WHILE IT IS LIVE. ALWAYS ISOLATE YOUR AC SUPPLY BEFORE DISCONNECTING THE POWERCON CONNECTOR.

Voltage requirements

Your EPAK2500 will be supplied pre set to the voltage used in your area. The table below provides typical current draw figures for the EPAK2500.

AC Input	Current draw with amplifier running at Average Power	Current draw with amplifier running at Peak Power
250V	8,25 A	12.5 A
230V	9 A	14 A
115V	18 A	28 A

IF THE ON LED DOES NOT ILLUMINATE OR THE SYSTEM DOES NOT RESPOND TO AUDIO INPUT REMOVE AC POWER IMMEDIATELY. VERIFY THAT THE VOLTAGE IS WITHIN THE PROPER RANGE. IF THE PROBLEM PERSISTS, PLEASE CONTACT KV2 AUDIO OR AN AUTHORIZED SERVICE CENTER.

Cooling

The EPAK2500 has a comprehensive passive cooling system with demand-sensitive forced cooling back-up, speed controlled fans. This means that the cooling system never drives air across PCB boards, connectors or components ensuring prolonged electronic component lifespan and minimizing maintenance cycles.

It is important to have an adequate air supply around the amplifier allow the cooling air to flow. Do not expose amplifier heating to the direct sunlight.

If the heat sink gets too hot, its sensing circuit will open the output relay, disconnecting the load.

Upper panel

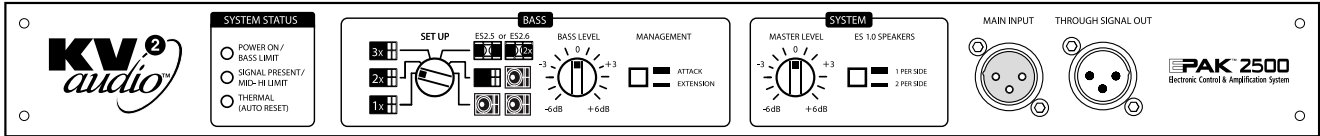

Power ON / Bass limit

This is a dual colour LED, when green it indicates that the AC power is on. When red it indicates that the audio bass amplifier limiter has been activated.

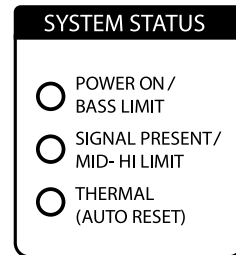

Signal preset / Mid - Hi limit

This is a dual colour LED, green indicates when audio signal is present at the EPAK2500's input. When red it indicates that the audio mid-hi amplifier limiter has been activated.

Thermal (auto reset)

When red it indicates that the thermal limit of the EPAK2500 has been exceeded and the unit has shut down because of this.

BASS SECTION

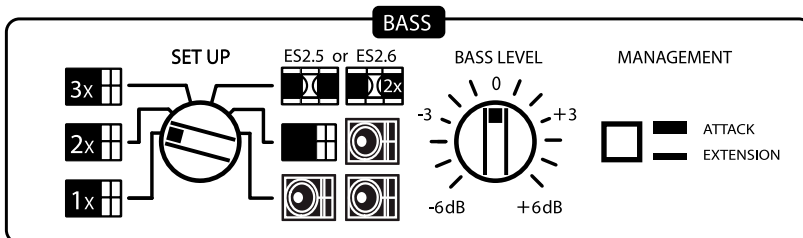

Sub Set Up

This switch is set according to which combination of subwoofers is being used with the system. Refer to 'Using the System' for further information, the various combinations are listed in the table within this section.

Bass Level

This is the level control for the Internal Subwoofer output; it is 'post' the Master Level control.

Management

This switch turns on the low frequency enhancement circuitry (EXTENSION position) which boosts frequencies around 60Hz to enhance the lowest frequency band.

Upper panel

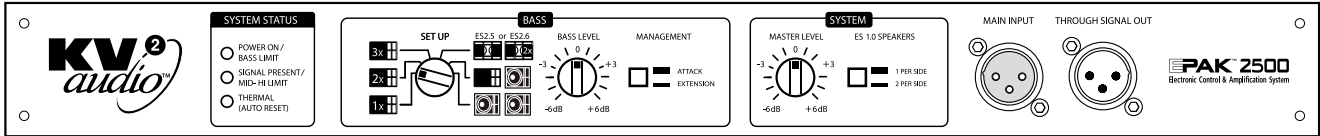

SYSTEM SECTION

Master level

This is the master level control for the system and will affect both the ES1.0 and the subwoofer outputs.

ES1.0 Speakers

Press this switch when using double ES1.0 system.
When normal single ES1.0 system is used, this button is depressed.

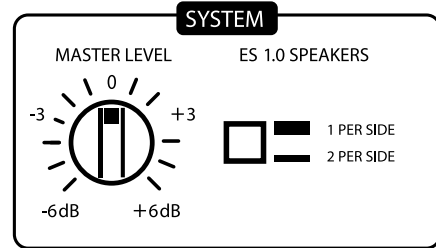

SIGNAL INPUT

Main input

This is the main system balanced signal input connector.

Through signal out

'Through Signal Output' connector associated in parallel with Main input for sending unprocessed signal to other devices, such as more EPAK2500's to power more ES1.0's in a system.

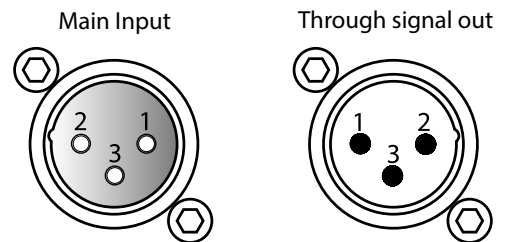

- 1 = Ground
- 2 = Hot (+)
- 3 = Cold (-)

Bottom panel

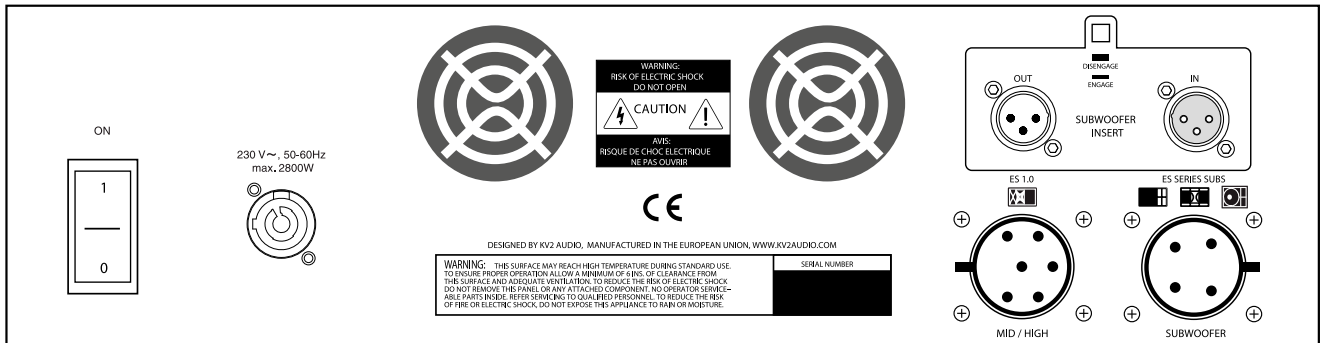

AC Mains switch

The EPAK2500 has a combination AC Mains switch/circuit breaker on the bottom panel. If the switch shuts off during normal use, push it back to the ON position once. If it will not stay on you should take the unit to qualified service personnel to have it serviced.

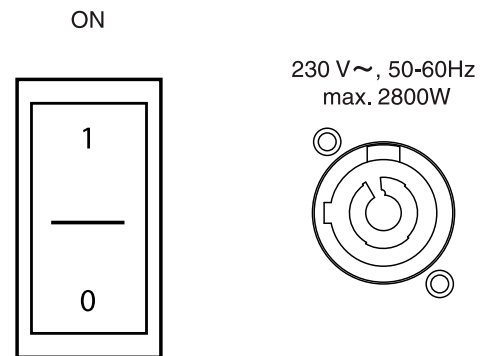

PowerCon Power Connector

Accepts a standard PowerCon terminated AC cable.

Fans

The internal temperature sensor will activate the fans during high temperature conditions.



SUBWOOFER INSERT

Allows you to insert into the subwoofer signal path more components, such as delay lines etc. It is activated by pressing ENGAGE button. In case of non-use this button must be depressed - DISENGAGE. Subwoofer input and output are balanced XLR, output can be used as an output for external subwoofer system (EX2.5).

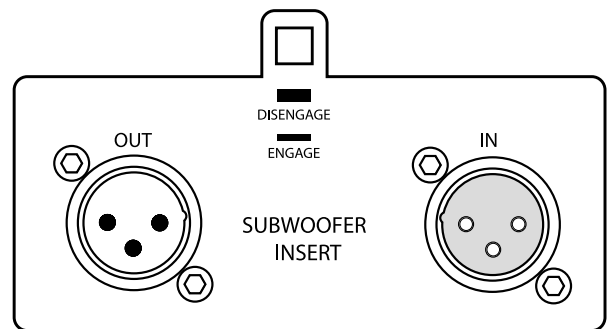

ES1.0 AP6 connector

Accepts a standard AP6 terminated loudspeaker cable for connecting up to a single ES1.0 cabinet. We recommend using 2.5mm/core cables..

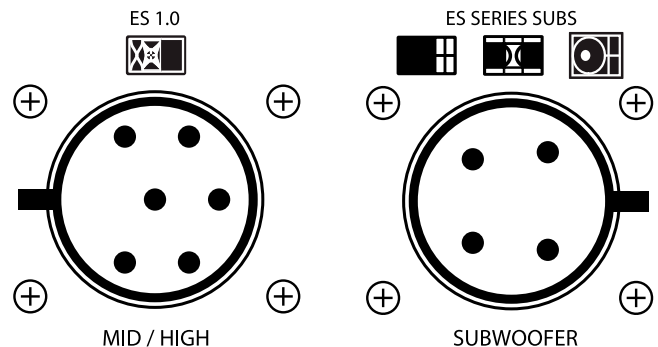

Subwoofer AP4 connector

Accepts a standard AP4 terminated loudspeaker cable for connecting up to various ES series subwoofers. We recommend using 2.5mm/core cables.

Using the System

Normal set up

The EPAK2500 is designed to actively power one ES1.0 cabinet and associated subwoofer systems. For Normal Mode operation signal is applied to the 'Main Input' connector and the 'Insert' switch would be in the 'Disengage' position.

Six different combinations of subwoofers setup are accommodated for when using the EPAK2500. The combinations are as follows:

EPAK2500 Setting	Subwoofer configuration
1	1 x ES1.5
2	2 x ES1.5
3	3 x ES1.5
4	1 x ES2.5 or 2 x ES2.6
5	1 x ES1.5 + 1 x ES1.8
6	2 x ES1.8

Setting 1

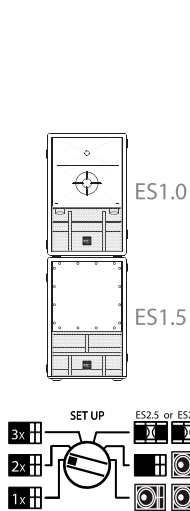

Setting 2

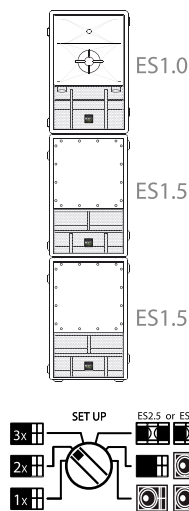

Setting 3

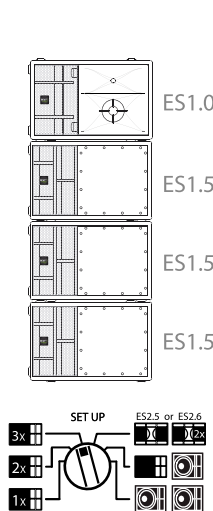

Setting 4

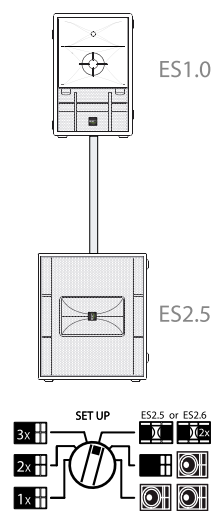

Setting 4

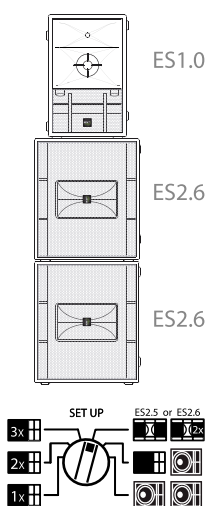

Setting 5

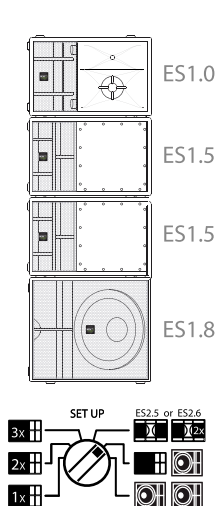

Setting 5

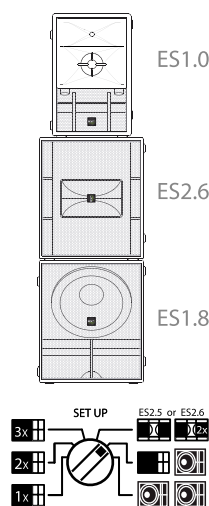

Setting 6

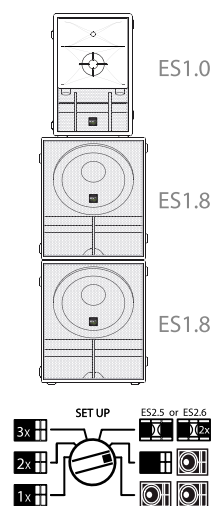

Using the System

Using the subwoofer insert

The subwoofer insert point gives you the ability to 'insert' a signal processing device into the ES subwoofer signal chain. For instance in some instances it may be necessary to 'delay' the signal going to the subwoofer using a delay line. The Main Input is used as the system input, as per Normal Mode, but the subwoofer insert switch is switched to 'Engage'. A feed is taken to the delay line from the 'Pre Control Out' connector and the return from the delay line is connected to the 'Mid/Hi In' connector as per the diagram:

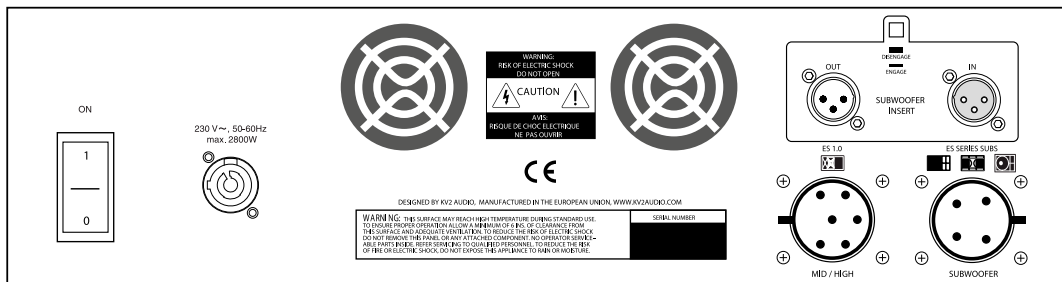

EPAK2500 lower panel

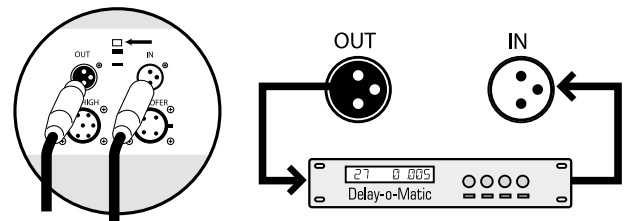

Device connected into subwoofer insert

EPAK2500 Dimensions

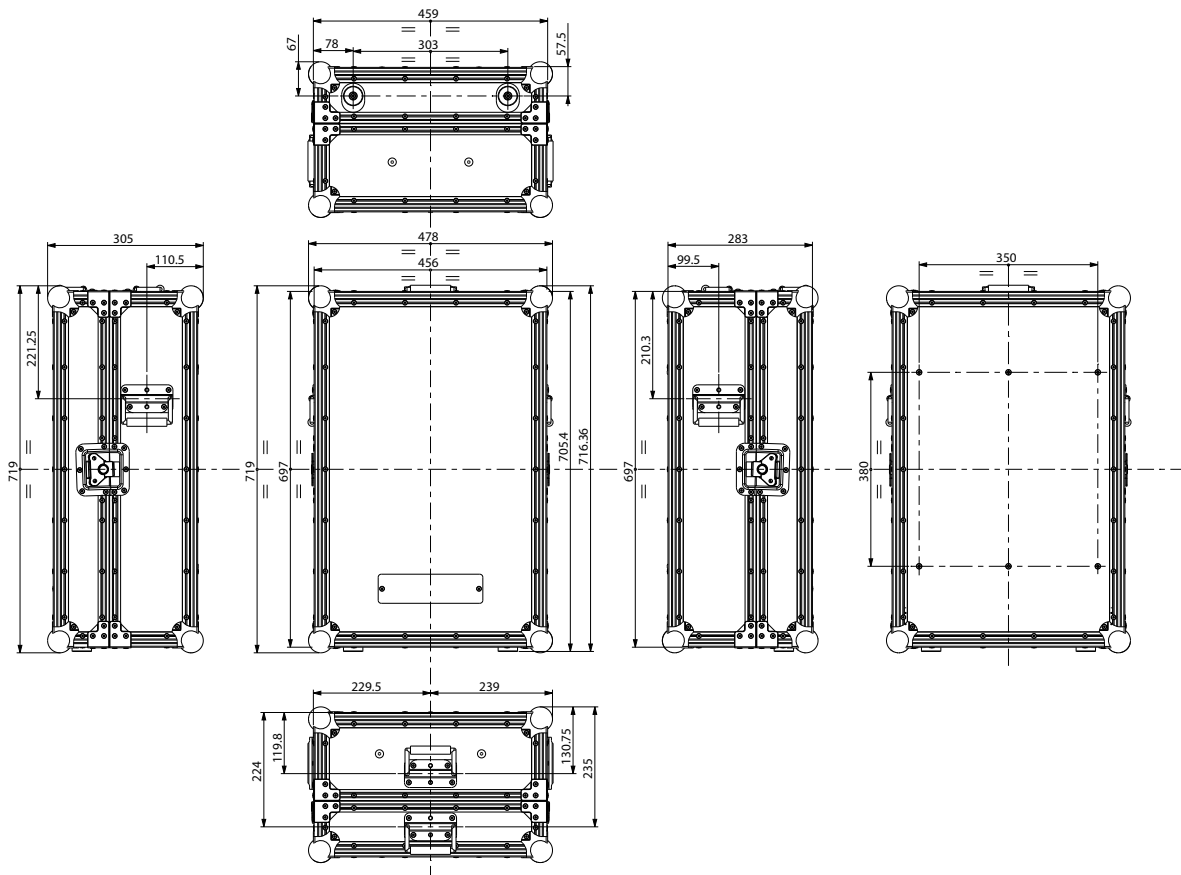

Block diagram

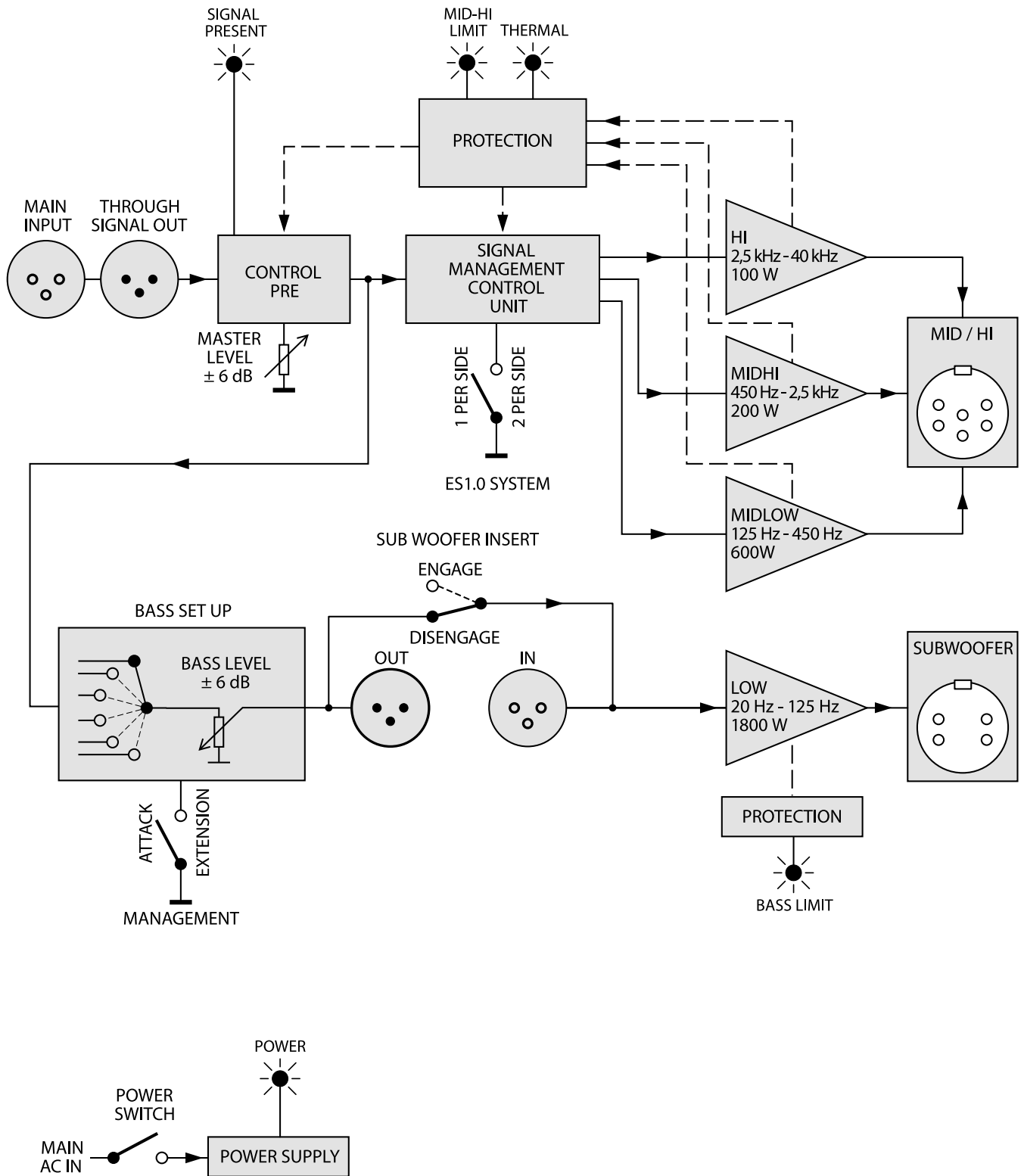

EPAK2500 · Block diagram

Specifications

High Frequency Amplifier Specification

Type	Class AB Push-Pull low inter-modulation Mosfet design with transformer balanced output
Rated Continuous Power	100W
Distortion	<0.05%
Operating Bandwidth	2.5kHz to 28kHz

Mid Frequency Amplifier Specification

Type	Class AB Push-Pull low inter-modulation Mosfet design with transformer balanced output
Rated Continuous Power	200W
Distortion	<0.05%
Operating Bandwidth	500Hz to 2.5kHz

Mid-Bass Frequency Amplifier Specification

Type	High efficiency, Current-Enhancing, Switched-Rail Amplifier
Rated Continuous Power	600W
Distortion	<0.05%
Operating Bandwidth	130Hz to 500Hz

Low Frequency Amplifier Specification

Type	High efficiency, Current-Enhancing, Switched-Rail Amplifier
Rated Continuous Power	1600W
Distortion	<0.05%
Operating Bandwidth	20Hz to 130Hz

Signal Input

Input Sensitivity	1.0V RMS
Input Impedance	20kΩ (balanced)

Speaker Output

Speaker Output	AP6 (Mid-Hi), AP4 (Sub)
----------------	-------------------------

Power

Power Connector	Neutrik PowerCon®
Operating Voltage Range	100 to 120V@60Hz 205 to 240V@50Hz 225 to 260V@50Hz
Recommended Amperage	20A 115V 10A 230V 10A 250V

Physical Dimensions

Height	719 mm (28.30")
Width	478 mm (18.82")
Depth	305 mm (12")
Weight	32 kg (70.4lbs)

ES Mid/Hi speaker cable MH15, AP6 connectors - 1,5 m
 part name: **MH15**
 part number: **KVV 987 147**
 - 1,5 m (5ft), Mid/Hi Module hook-up



Amphenol AP6 cable-mount female connector
 part name: **AP-6-11**
 part number: **KVV 987 050**



ES Mid/Hi speaker cable MH60, AP6 connectors - 6 m
 part name: **MH60**
 part number: **KVV 987 125**
 - 6 m (20ft), Mid/Hi Module hook-up



Amphenol AP6 cable-mount male connector
 part name: **AP-6-12**
 part number: **KVV 987 051**



ES Mid/Hi speaker cable MH120, AP6 connectors - 12 m
 part name: **MH120**
 part number: **KVV 987 126**
 - 12 m (40ft), Mid/Hi Module hook-up



Amphenol AP4 cable-mount female connector
 part name: **AP-4-11**
 part number: **KVV 987 048**



ES Mid/Hi speaker cable MH180, AP6 connectors - 18 m
 part name: **MH180**
 part number: **KVV 987 127**
 - 18 m (60ft), Mid/Hi Module hook-up



Amphenol AP4 cable-mount male connector
 part name: **AP-4-12**
 part number: **KVV 987 049**



ES Bass speaker cable LF15, AP4 connectors - 1,5 m
 part name: **LF15**
 part number: **KVV 987 121**
 - 1,5 m (5ft)
 - for ES Bass Module daisy-chaining



ES Cable kit
 part name: **CABLE-KIT**
 part number: **KVV 987 047**
 The ES Cable Pack consist of four high-quality Amphenol AP cable assemblies designed for use with ES Series.



- 2 pcs LF15
- 1pc LF40
- 1pc MH60

ES Bass speaker cable LF40, AP4 connectors - 4 m
 part name: **LF40**
 part number: **KVV 987 122**
 - 4 m (13ft)
 - for ES Bass Module hook-up



ES Bass speaker cable LF100, AP4 connectors - 10 m
 part name: **LF100**
 part number: **KVV 987 123**
 - 10 m (33ft)
 - for ES Bass Module hook-up



EPAK2500 Wall mounting kit
 part name: **WALLMNT - BRCKT**
 part number: **KVV 987 332**

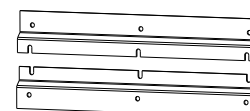

ES Bass speaker cable LF200, AP4 connectors - 20 m
 part name: **LF200**
 part number: **KVV 987 124**
 - 20m (66ft)
 - for ES Bass Module hook-up



Warranty

Your EPAK2500 is covered against defects in material and workmanship.

Refer to your supplier for more details.

Service

In the unlikely event that your EPAK2500 develops a problem, it must be returned to an authorized distributor, service centre or shipped directly to our factory. Because of the complexity of the design and the risk of electrical shock, all repairs must be attempted only by qualified technical personnel.

If the unit needs to be shipped back to the factory, it must be sent in its original carton. If improperly packed, the unit may be damaged.

To obtain service, contact your nearest KV2 Audio Service Centre, Distributor or Dealer.



The Future of Sound.
Made Perfectly Clear.

KV2 Audio International

Nádražní 936, 399 01 Milevsko
Czech Republic

Tel.: +420 383 809 320

Email: info@kv2audio.com

www.kv2audio.com

KVV120000-00-04-0